



ZASTOSOWANIE

Seria wentylatorów HXBR ECOWATT znajduje zastosowanie w różnorodnych instalacjach wentylacji mechanicznej pomieszczeń przemysłowych i użytkowych (sklepy, garaże, magazyny, hale produkcyjne) jak również w urządzeniach chłodniczych.

KONSTRUKCJA

Wentylator osiowy przystosowany do montażu ściennego. Obudowa wykonana z galwanizowanej blachy stalowej, wirnik z tworzywa sztucznego o specjalnie profilowanych łopatkach, niski poziom hałasu, zabezpieczenie przed korozją poprzez malowanie odporną farbą poliestrową. Standardowy przepływ powietrza (A): silnik->wirnik.

SILNIK ELEKTRYCZNY

Wentylatory wyposażone są w bezszczotkowe silniki jednofazowe 230V $\pm 10\%$ 50/60Hz. Stopień ochrony IP44. Łożyska kulkowe. Silniki posiadają termiczne zabezpieczenie przed przeciążeniem oraz analogowe wejście sterujące 0-10V. Możliwość płynnej regulacji obrotów potencjometrem znajdującym się na puszcze przyłączeniowej lub za pomocą zewnętrznego regulatora REB-ECOWATT. Temperatura otoczenia dla pracy silnika od -20°C do $+40^{\circ}\text{C}$. Schemat podłączenia elektrycznego: rys. 9, str. 663.



www



Zwarta konstrukcja

Niskoprofilowa konstrukcja zapewnia wysoką wydajność przy jednoczesnej minimalizacji poziomu hałasu.

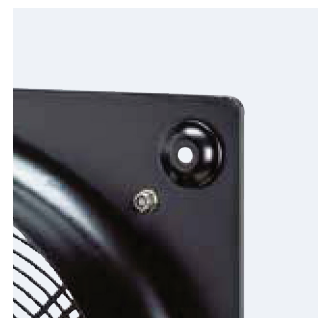

Zabezpieczenie przed korozją

Obudowa zabezpieczona katalforetycznie oraz wykończona farbą poliestrową. Elementy złączne ze stali nierdzewnej.



Wysokowydajny wirnik „AMAX”

Zaprojektowany tak aby zapewnić wysokie parametry pracy oraz sprawność przy zachowaniu jak najniższego poziomu hałasu. Wykonany ze wzmocnionego poliamidu.

DANE TECHNICZNE

Typ	napiecie wejściowe	prędkość obrotowa	pobór mocy max	nateżenie	wydajność max	poziom ciśnienia akust*	masa	ErP	nr artykułu
	[V]	[obr/min]	[W]	[A]	[m³/h]	[dB(A)]	[kg]		
HXBR-200 ECOWATT	10	2800	103	0,7	1335	57	4	nie podlega P < 125W	43025730
	8	2680	91	0,7	1292	56			
	6	2110	46	0,3	1025	50			
	4	1525	19	0,2	705	43			
HXBR-250 ECOWATT	10	2270	118	0,8	2070	60	4,5	nie podlega P < 125W	43025735
	8	1910	70	0,5	1710	56			
	6	1520	37	0,3	1360	51			
	4	1140	17	0,1	1015	45			
HXBR-300 ECOWATT	10	1749	164	1,1	2835	57	6	2015	43025740
	8	1605	128	0,9	2620	55			
	6	1325	74	0,5	2155	49			
	4	1040	39	0,3	1670	43			
HXBR-315 ECOWATT	10	1675	167	1,1	3015	57	6	2015	43025745
	8	1505	121	0,8	2695	55			
	6	1190	63	0,4	2160	50			
	4	885	29	0,2	1590	42			
HXBR-355 ECOWATT	10	1550	184	1,2	3640	60	8	2015	43025750
	8	1420	141	0,9	3330	58			
	6	1195	84	0,6	2785	54			
	4	960	46	0,3	2230	49			
HXBR-400 ECOWATT	10	1450	375	1,6	5730	61	8,5	2015	43025755
	8	1270	256	1,1	5025	58			
	6	1035	144	0,6	4140	53			
	4	784	70	0,3	3095	48			
HXBR-450 ECOWATT	10	1250	352	1,5	6440	61	9	2015	43025760
	8	1120	254	1,1	5780	58			
	6	920	146	0,6	4740	53			
	4	725	77	0,4	3760	48			

* Poziom ciśnienia akustycznego mierzony w odległości równej 3 średnicom, jednak nie mniej niż 1,5m.

CHARAKTERYSTYKI PRACY

- q_v - Przepływ powietrza [m^3/h] lub [m^3/s]
- p_{sf} - Ciśnienie statyczne [Pa]
- p_a - Spadek ciśnienia na siatce [Pa]
- SFP - Moc właściwa wentylatora [$W/(m^3/s)$]
- P - Pobór mocy [W]
- Kategoria pomiarowa: A
- Kategoria sprawności: statyczna
- Sprawność wentylatora wyznaczona bez regulatora
- Wentylator badany bez siatki ochronnej
- Charakterystyka wentylatora wyznaczona zgodnie z ISO 5801
- Poziom ciśnienia akustycznego dB(A), wyznaczony w wolnej przestrzeni w odległości 3 średnic od wentylatora, jednak nie mniej niż 1,5m.

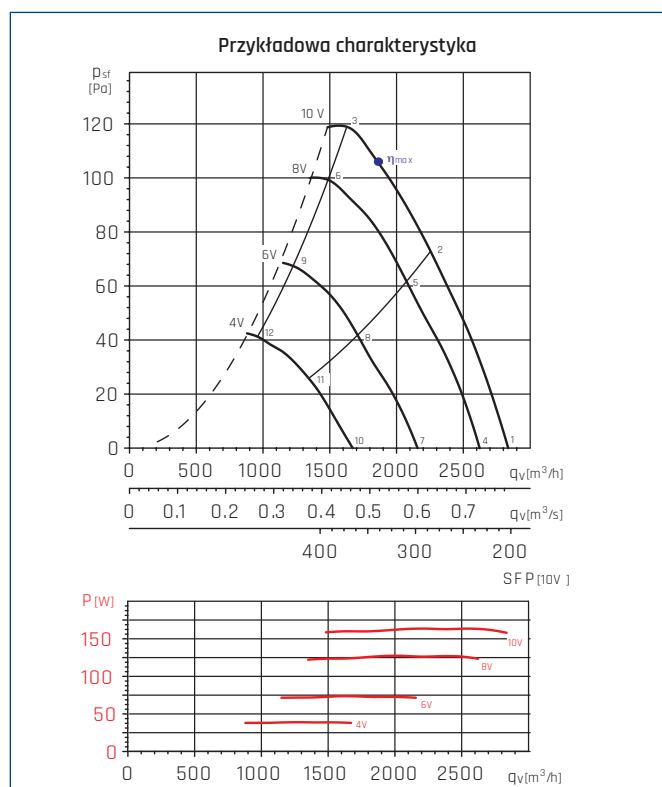

MC	Kategoria pomiarowa
EC	Kategoria sprawności
VSD	Regulacja prędkości
SR	Ilość biegów
η [%]	Sprawność
N	Współczynnik sprawności
[kW]	Pobór mocy
[m^3/h]	Wydajność
[Pa]	Ciśnienie statyczne
[RPM]	Prędkość obrotowa

MC	EC	VSD	SR	η [%]	N	[kW]	[m^3/h]	[Pa]	[RPM]
A	Statyczna	Tak	1	39,4	50,8	0,159	1768	112	1748

● - punkt najwyższej sprawności wentylatora.

CHARAKTERYSTYKI PRACY

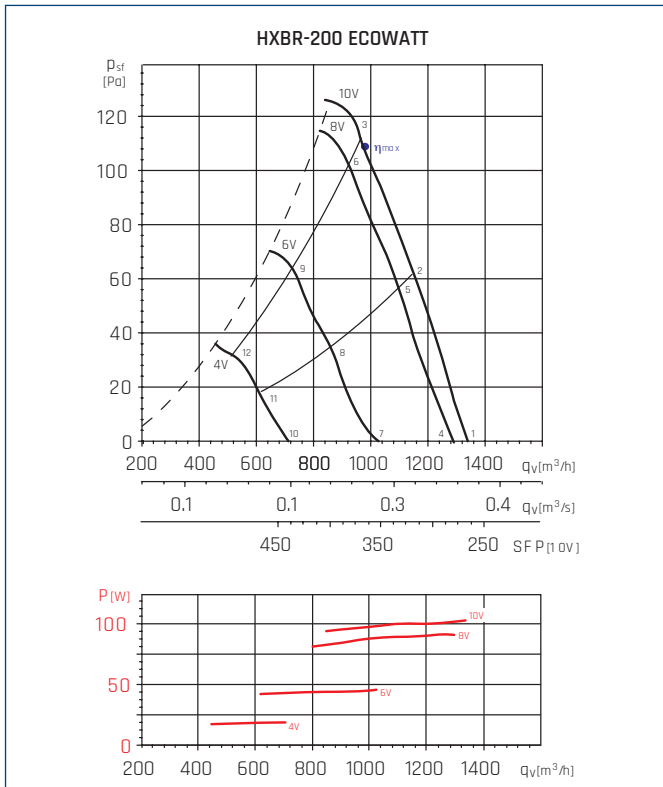

● - punkt najwyższej sprawności wentylatora.

CHARAKTERYSTYKA AKUSTYCZNA

Częst. Hz/dB(A)		65	125	250	500	1000	2000	4000	8000	L _{WA}
1	wlot	43	50	61	61	69	69	66	61	74
	wylot	43	50	66	66	70	69	65	61	75
2	wlot	44	48	60	60	66	66	63	58	71
	wylot	41	49	63	65	68	66	63	58	73
3	wlot	48	54	62	63	66	66	63	56	71
	wylot	43	53	64	66	68	66	63	57	73
4	wlot	41	49	59	60	67	68	65	60	72
	wylot	42	49	64	65	68	68	64	59	73
5	wlot	41	48	58	59	64	65	62	56	70
	wylot	40	49	61	64	67	65	62	56	71
6	wlot	44	52	60	61	64	65	62	56	70
	wylot	42	52	61	65	66	65	61	56	71
7	wlot	35	49	52	56	60	63	60	53	67
	wylot	37	53	55	59	62	62	59	52	67
8	wlot	36	47	50	54	57	61	57	49	64
	wylot	37	50	53	58	60	60	56	49	65
9	wlot	36	49	52	55	57	59	55	48	64
	wylot	38	50	54	58	59	59	55	48	65
10	wlot	30	42	43	49	53	57	51	40	60
	wylot	30	44	46	52	54	54	50	39	59
11	wlot	30	41	42	48	50	55	48	38	57
	wylot	32	43	45	50	52	53	47	37	57
12	wlot	31	40	44	47	50	53	46	36	56
	wylot	32	42	46	50	51	52	46	36	57

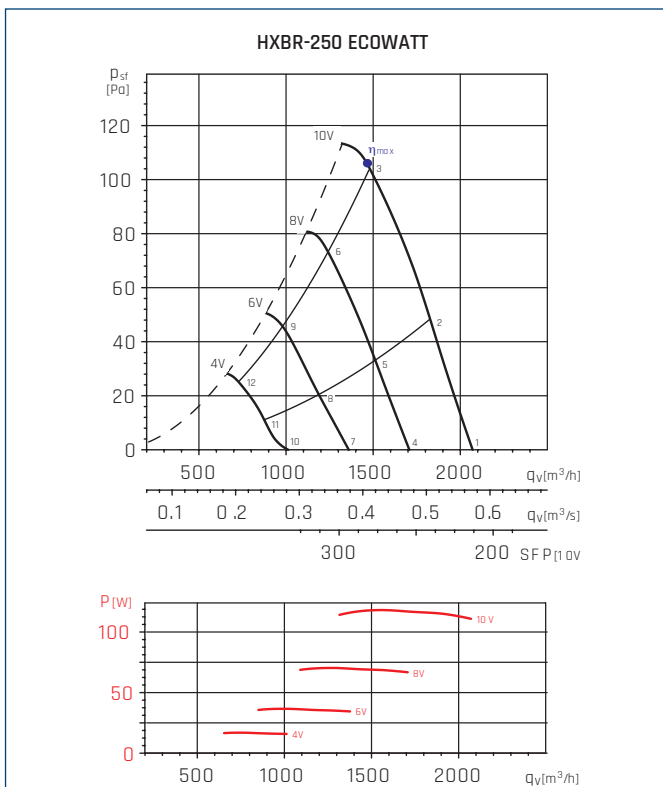

● - punkt najwyższej sprawności wentylatora.

Częst. Hz/dB(A)		65	125	250	500	1000	2000	4000	8000	L _{WA}
1	wlot	39	52	59	67	69	70	67	59	75
	wylot	48	54	60	68	70	69	66	59	75
2	wlot	40	51	59	64	69	69	66	58	74
	wylot	44	52	59	65	69	68	65	58	74
3	wlot	42	55	60	64	68	67	63	56	72
	wylot	43	52	59	64	68	66	61	55	72
4	wlot	36	51	54	63	65	66	63	54	71
	wylot	43	51	56	63	65	65	62	53	70
5	wlot	37	50	54	61	65	66	62	53	70
	wylot	39	52	56	62	65	64	61	53	70
6	wlot	38	52	55	59	63	63	58	50	68
	wylot	38	51	55	60	63	61	56	49	67
7	wlot	34	45	52	57	59	62	56	45	65
	wylot	36	46	52	57	59	59	55	45	64
8	wlot	34	46	51	56	59	62	56	45	65
	wylot	35	48	50	56	59	59	55	45	64
9	wlot	36	48	51	55	58	60	52	43	64
	wylot	37	46	51	55	57	56	50	41	61
10	wlot	31	39	50	51	56	58	47	34	61
	wylot	32	41	46	50	52	52	46	33	57
11	wlot	31	38	48	50	54	56	46	32	59
	wylot	32	40	44	49	52	51	45	32	56
12	wlot	36	43	49	50	54	56	44	32	60
	wylot	34	39	45	48	50	48	41	29	54

CHARAKTERYSTYKI PRACY

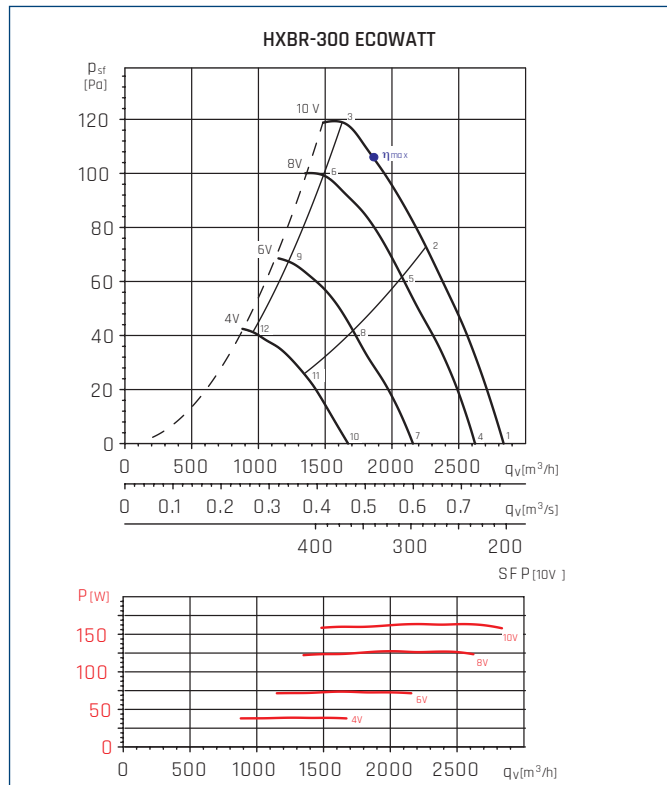

MC	EC	VSD	SR	η [%]	N	[kW]	[m³/h]	[Pa]	[RPM]
A	Statyczna	Tak	1	39,4	50,8	0,159	1768	112	1748

● - punkt najwyższej sprawności wentylatora.

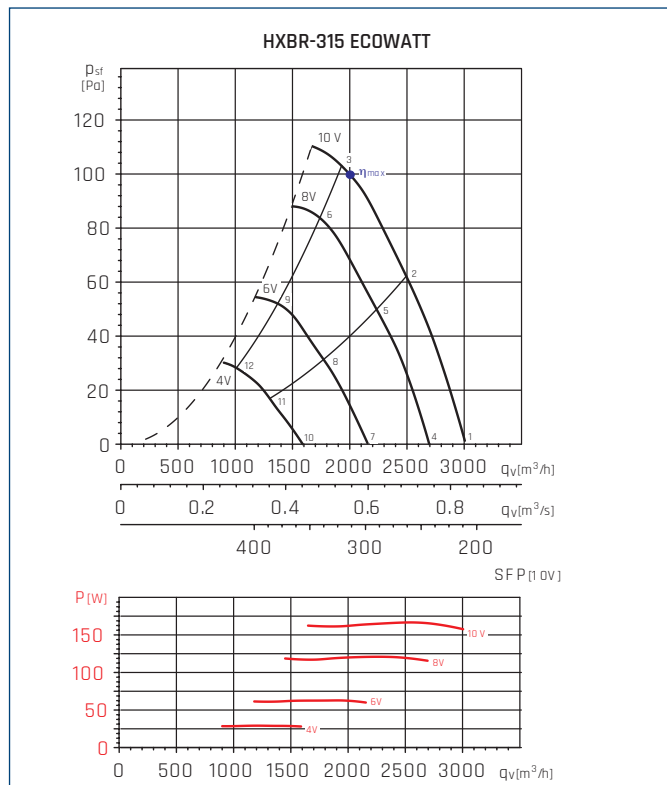

MC	EC	VSD	SR	η [%]	N	[kW]	[m³/h]	[Pa]	[RPM]
A	Statyczna	Tak	1	39,2	50,5	0,162	1984	101	1673

● - punkt najwyższej sprawności wentylatora.

CHARAKTERYSTYKA AKUSTYCZNA

Czest. Hz/dB(A)		65	125	250	500	1000	2000	4000	8000	L _{WA}
1	wlot	36	56	56	66	69	70	66	56	75
	wylot	47	61	60	69	69	69	67	58	75
2	wlot	42	54	53	62	65	64	62	54	70
	wylot	42	59	58	65	66	64	62	55	71
3	wlot	54	57	61	65	67	67	63	54	72
	wylot	50	58	60	65	67	65	62	54	72
4	wlot	35	52	54	64	67	68	64	53	72
	wylot	48	57	57	67	68	68	65	55	73
5	wlot	40	51	51	60	63	63	60	51	68
	wylot	40	55	55	63	63	62	60	53	69
6	wlot	49	53	55	60	63	63	59	51	68
	wylot	49	55	58	63	65	64	60	52	70
7	wlot	33	45	53	59	63	64	59	46	68
	wylot	41	50	55	61	63	64	59	48	68
8	wlot	36	43	49	54	58	59	55	44	63
	wylot	36	48	52	56	57	58	54	45	63
9	wlot	44	47	50	54	57	57	53	44	62
	wylot	44	49	53	57	59	58	54	45	64
10	wlot	33	39	48	53	57	58	51	36	62
	wylot	38	41	51	54	57	58	51	38	62
11	wlot	32	37	43	47	51	52	46	32	56
	wylot	37	40	46	49	51	52	46	34	57
12	wlot	37	41	45	48	52	52	45	33	56
	wylot	38	43	48	50	53	53	46	34	58

Czest. Hz/dB(A)		65	125	250	500	1000	2000	4000	8000	L _{WA}
1	wlot	39	61	58	66	69	69	65	55	74
	wylot	48	63	59	67	68	68	65	56	74
2	wlot	40	57	58	64	66	66	62	54	71
	wylot	42	58	61	65	66	65	61	53	71
3	wlot	49	58	62	65	67	66	61	53	72
	wylot	48	60	62	66	67	65	60	53	72
4	wlot	39	59	55	62	65	66	62	51	71
	wylot	45	61	58	64	66	66	62	52	71
5	wlot	40	55	55	62	63	63	60	50	69
	wylot	40	57	58	63	63	62	58	50	69
6	wlot	47	55	58	63	64	63	58	49	69
	wylot	46	57	59	63	64	62	57	49	69
7	wlot	38	52	55	57	61	62	56	44	66
	wylot	38	52	54	58	60	61	55	44	66
8	wlot	38	49	52	57	58	59	54	42	64
	wylot	37	49	53	56	57	57	52	41	63
9	wlot	41	49	53	56	57	57	51	41	62
	wylot	41	51	54	56	57	56	50	40	62
10	wlot	43	40	47	48	53	53	44	30	57
	wylot	44	41	47	49	53	53	44	31	57
11	wlot	38	42	46	46	51	52	43	30	56
	wylot	39	42	46	48	50	51	42	29	55
12	wlot	38	42	45	46	49	48	40	29	54
	wylot	40	43	46	47	49	48	40	28	54

CHARAKTERYSTYKI PRACY

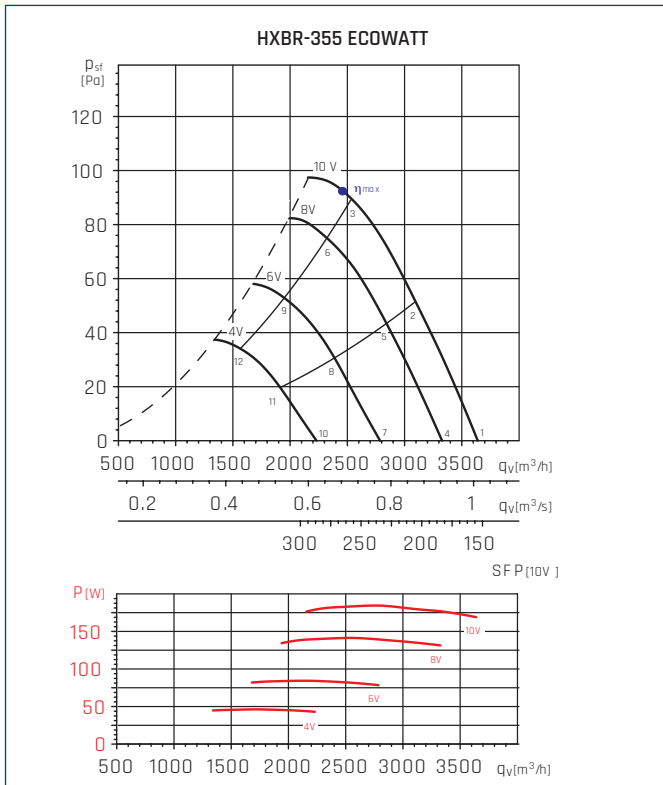

MC	EC	VSD	SR	η [%]	N	[kW]	[m³/h]	[Pa]	[RPM]
A	Stacyjna	Tak	1	39,4	50,4	0,182	2457	93	1549

• - punkt najwyższej sprawności wentylatora.

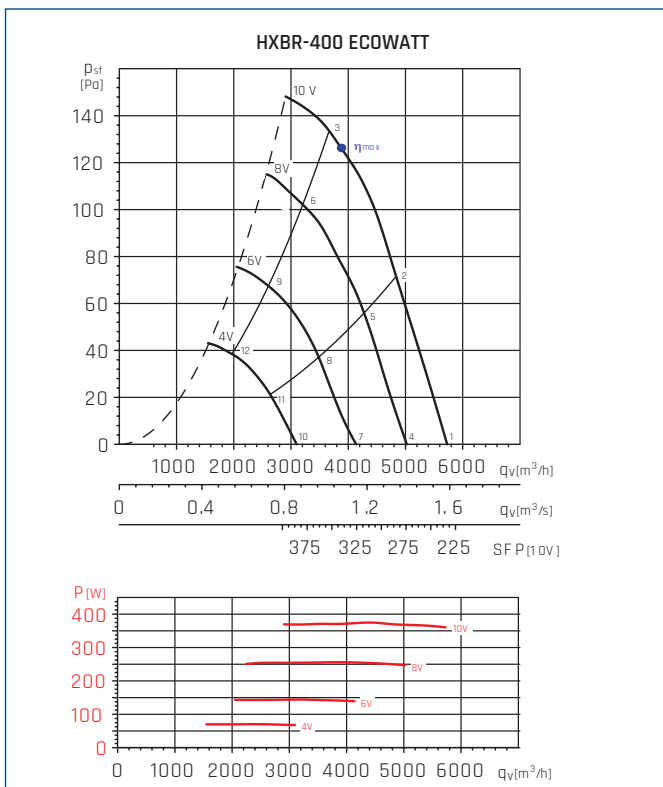

MC	EC	VSD	SR	η [%]	N	[kW]	[m³/h]	[Pa]	[RPM]
A	Stacyjna	Tak	1	41	50,1	0,37	3771	130	1449

• - punkt najwyższej sprawności wentylatora.

CHARAKTERYSTYKA AKUSTYCZNA

Częst. Hz/dB(A)		65	125	250	500	1000	2000	4000	8000	L _{WA}
1	wlot	41	63	61	68	71	72	68	58	77
	wylot	56	60	61	70	72	71	68	60	77
2	wlot	42	60	59	65	68	69	66	57	74
	wylot	45	57	59	67	70	69	67	59	75
3	wlot	45	60	61	64	66	68	65	56	73
	wylot	44	56	60	64	66	67	66	58	72
4	wlot	40	60	61	67	69	70	66	55	75
	wylot	54	57	59	67	70	69	66	57	75
5	wlot	41	58	59	63	66	68	65	55	72
	wylot	50	58	64	65	67	67	63	54	73
6	wlot	45	57	60	62	65	67	63	54	71
	wylot	46	55	60	63	65	66	63	55	71
7	wlot	40	55	58	62	65	66	61	49	70
	wylot	46	51	57	63	65	65	61	50	70
8	wlot	42	53	55	59	62	64	60	48	68
	wylot	43	50	55	62	63	64	61	50	69
9	wlot	39	53	56	56	60	63	58	48	67
	wylot	41	48	55	58	61	63	59	49	67
10	wlot	49	46	53	56	59	61	54	41	65
	wylot	44	43	53	56	59	60	54	42	64
11	wlot	47	44	49	54	58	60	52	39	63
	wylot	44	44	53	56	58	59	54	42	64
12	wlot	47	43	48	50	56	58	50	38	61
	wylot	42	44	49	52	55	58	52	40	61

Częst. Hz/dB(A)		65	125	250	500	1000	2000	4000	8000	L _{WA}
1	wlot	46	57	60	68	73	71	67	59	76
	wylot	65	65	65	71	72	70	67	60	77
2	wlot	42	55	59	66	71	70	67	59	75
	wylot	54	58	63	69	71	69	67	59	75
3	wlot	53	55	61	64	68	68	65	59	73
	wylot	55	58	65	68	70	68	66	59	75
4	wlot	43	54	58	65	69	68	63	55	73
	wylot	59	61	63	67	69	67	63	56	74
5	wlot	40	52	56	63	67	67	63	54	72
	wylot	48	54	61	65	67	66	63	55	72
6	wlot	50	52	57	61	65	66	62	55	70
	wylot	49	54	61	64	66	66	63	55	72
7	wlot	49	48	54	60	64	63	58	48	68
	wylot	54	54	58	61	64	62	58	48	69
8	wlot	44	45	51	58	62	62	58	47	67
	wylot	45	49	56	59	63	62	58	48	67
9	wlot	46	49	53	57	61	61	57	47	66
	wylot	43	49	56	58	62	62	58	48	67
10	wlot	37	41	55	54	58	56	49	38	62
	wylot	44	45	54	55	58	56	49	39	62
11	wlot	35	39	55	52	57	56	49	38	62
	wylot	38	41	52	53	57	56	50	38	61
12	wlot	36	41	55	52	56	55	49	38	61
	wylot	38	44	52	53	58	56	49	38	61

CHARAKTERYSTYKI PRACY

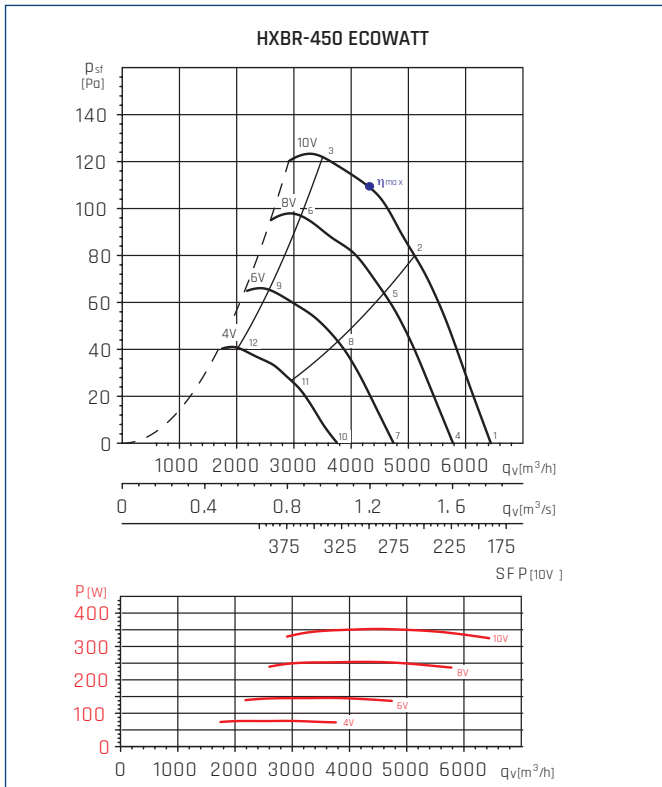

MC	EC	VSD	SR	η [%]	N	[kW]	[m³/h]	[Pa]	[RPM]
A	Stacyjna	Tak	1	41,9	51,1	0,352	4370	108	1249

● - punkt najwyższej sprawności wentylatora.

CHARAKTERYSTYKA AKUSTYCZNA

Częst. Hz/dB(A)		65	125	250	500	1000	2000	4000	8000	L _{WA}
1	wlot	46	57	60	68	73	71	67	59	76
	wylot	65	65	65	71	72	70	67	60	77
2	wlot	42	55	59	66	71	70	67	59	75
	wylot	54	58	63	69	71	69	67	59	75
3	wlot	53	55	61	64	68	68	65	59	73
	wylot	55	58	65	68	70	68	66	59	75
4	wlot	43	54	58	65	69	68	63	55	73
	wylot	59	61	63	67	69	67	63	56	74
5	wlot	40	52	56	63	67	67	63	54	72
	wylot	48	54	61	65	67	66	63	55	72
6	wlot	50	52	57	61	65	66	62	55	70
	wylot	49	54	61	64	66	66	63	55	72
7	wlot	49	48	54	60	64	63	58	48	68
	wylot	54	54	58	61	64	62	58	48	69
8	wlot	44	45	51	58	62	62	58	47	67
	wylot	45	49	56	59	63	62	58	48	67
9	wlot	46	49	53	57	61	61	57	47	66
	wylot	43	49	56	58	62	62	58	48	67
10	wlot	37	41	55	54	58	56	49	38	62
	wylot	44	45	54	55	58	56	49	39	62
11	wlot	35	39	55	52	57	56	49	38	62
	wylot	38	41	52	53	57	56	50	38	61
12	wlot	36	41	55	52	56	55	49	38	61
	wylot	38	44	52	53	58	56	49	38	61

WYMIARY [mm]

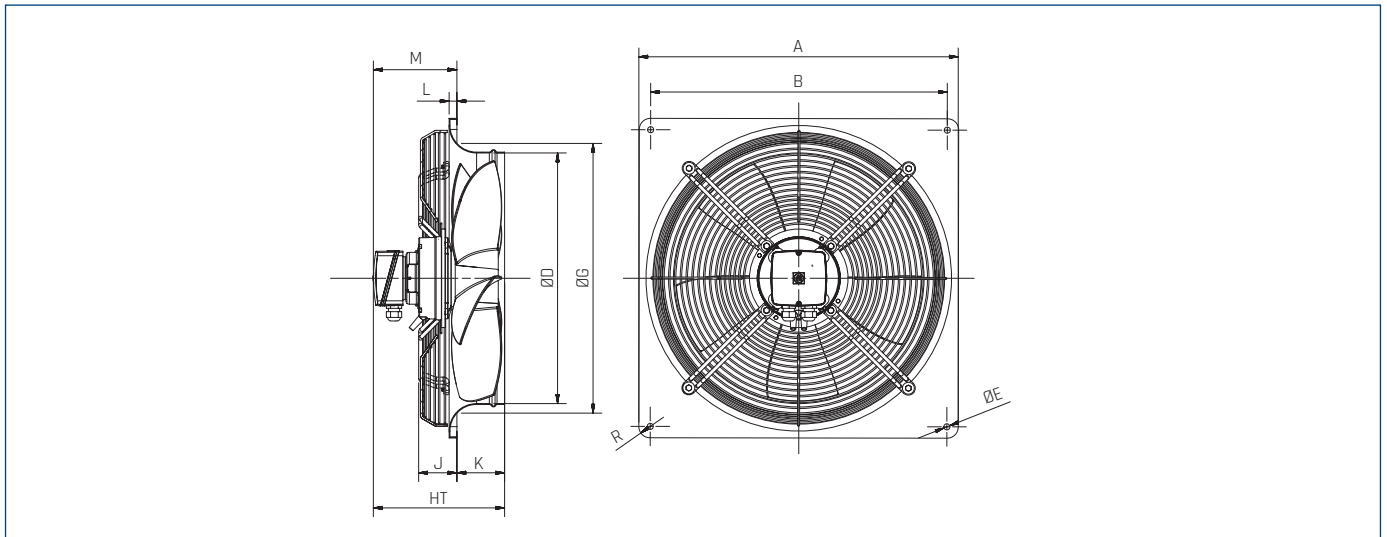

Typ	A	B	D	E	G	HT	J	K	L	M	R
200	312	260	200	7	210	190	70	46	6	138	20
250	370	320	254	7	264	190	70	48	6	136	20
300	430	380	305	9	324	190	55	71	11	108	20
315	430	380	317	9	330	190	55	71	11	108	20
355	485	435	358	9	378	190	56	74	12	104	20
400	540	490	403	9	426	232	62	88	12	132	20
450	576	535	452	11	487	237	69	86	14	137	20

AKCESORIA MONTAŻOWE

Wentylator	żaluzja wywiewna	
	PER-W/N - tworzywo sztuczne	PER-CN - aluminium
HXBR-250 ECOWATT	40520740	40520510
HXBR-315 ECOWATT	40520750	40520520
HXBR-355 ECOWATT	40520760	40520520
HXBR-400 ECOWATT	40520765	40520530
HXBR-450 ECOWATT	40520770	40520540



żaluzje
PER-W
str. 324

żaluzje
PER-CN
str. 325

AKCESORIA ELEKTRYCZNE

Wentylator	termostat ścienny	termostat kanałowy	czujnik zanieczyszczeń	higrostat	regulator tyrystorowy
	TS	TK-1	SQA	HIG-2	REB ECOWATT
HXBR-200 ECOWATT	40025345	40025330	40025140	40025150	40025005
HXBR-250 ECOWATT	40025345	40025330	40025140	40025150	40025005
HXBR-300 ECOWATT	40025345	40025330	40025140	40025150	40025005
HXBR-315 ECOWATT	40025345	40025330	40025140	40025150	40025005
HXBR-355 ECOWATT	40025345	40025330	40025140	40025150	40025005
HXBR-400 ECOWATT	40025345	40025330	40025140	40025150	40025005
HXBR-450 ECOWATT	40025345	40025330	40025140	40025150	40025005



termostat
TS
str. 650

termostat
TK-1
str. 650

czujnik
SQA
str. 645

higrostat
HIG-2
str. 645

regulator
REB ECOWATT
str. 638