

Danvent DV

Modular Air Handling Unit

Bella Sky Hotel



Copyright: Systemair A/S
9. edition 2015

We accept no liability for printing
errors or alterations of products.

The dimensions and data used in this catalogue are a guideline only.
Accurate calculations must be made in SystemairCAD.

Modular Air Handling Unit

Danvent DV

The catalogue contains a technical description of the air handling unit series Danvent DV in the range 0,2-24 m³/s (750-86.000 m³/h).

Danvent DV is continually being optimized and added improvements. The result is extremely flexible air handling units, both in terms of design and function.

Danvent DV forms together with Systemair's other air handling unit series and ventilation products, the most complete product range in the market.

Systemair in Denmark

Danvent DV air handling units are produced in Denmark. At the Danish Systemair factory we have manufactured air handling units since 1977. Systemair in Denmark houses the group's expertise for large air handling units. We focus on development, manufacturing, sales, and consultations.

The Systemair Group

Systemair is an international group with its headquarters in Sweden and with sales companies all over the world. We offer a wide range of fans, fire, and smoke products and air distribution components.

Hasselager, Denmark



Contents

Introduction	3
Danvent DV	5
About the Danvent DV	6
Product Information	8
Standards and Certifications	9
Combination Examples	10
Functions	14
Damper	DVA 20
Damper	DVB 22
Mixing Damper	DVM 24
Mixing Damper	DVP 26
Compact Filter	DVG 28
Bag Filter	DVF 30
Rotary Heat Exchanger	DVC 32
Plate Heat Exchanger	DVQ 36
Run-around Coil Heat Exchangers	DVR 40
Heating Coil	DVH 42
Cooling Coil	DVK 44
Change-over Coil	DVHK 46
Integrated Reversible Heat Pump	DVU-HP 48
Air Humidifier	DVX 50
Plug Fan	DVE 52
Sound Attenuator	DVD 56
Inspection Section	DVI. 58
Empty Section	DVO 59
Outdoor Air Section	DVY 60
Supporting Legs 61
Base Frame	DVZ 61
Dimensions for Ducts 62
Duct Connection Part	DVT 63

Danvent DV



About the Danvent DV

Danvent DV is designed as a modular air handling unit. Each function is placed into an air handling unit casing consisting of one or more modules. The modular functions can be configured for many different applications to make up the heart of any ventilation system. The flexibility makes it possible to optimize the air handling unit for each project.

Sizes and airflows

The Danvent DV comes in a range of 14 different sizes, with airflow capacities from 0,2-24 m³/s or 750-86.000 m³/h, making it possible to always find the unit optimized for any given requirement.

Casing

The casing protects the inside functions and is very effective for thermal and sound insulation.

Functions

The Danvent DV features a number of well-dimensioned functions, presenting a choice between different heat exchanger systems, a range of fans, filters, heating and cooling coils and much more. This means the Danvent DV can be configured for many different applications, from individual fan units to advanced air handling units.

SystemairCAD

The product selection programme, SystemairCAD, ensures optimal design of the air handling unit functions. The programme is very user-friendly and makes it possible to quickly and easily combine air handling unit functions and perform technical calculations.

SystemairCAD calculates and optimizes the energy consumption and the calculated data are the basis for Eurovent certification and energy classification of Danvent DV. The programme uses a number of combination examples or basic versions. For these examples one can quickly add or remove features in order to easily design the desired air handling unit.

Fully-dimensioned drawings, plus logical construction and presentation of technical data provide easy overview, and the drawings can be exported to AutoCAD and Autodesk Revit. A plugin for MagiCAD and Autodesk Revit also makes it possible to export more intelligent files. Download SystemairCAD from www.systemair.com or local Systemair website.

Airflow capacities for DV air handling units

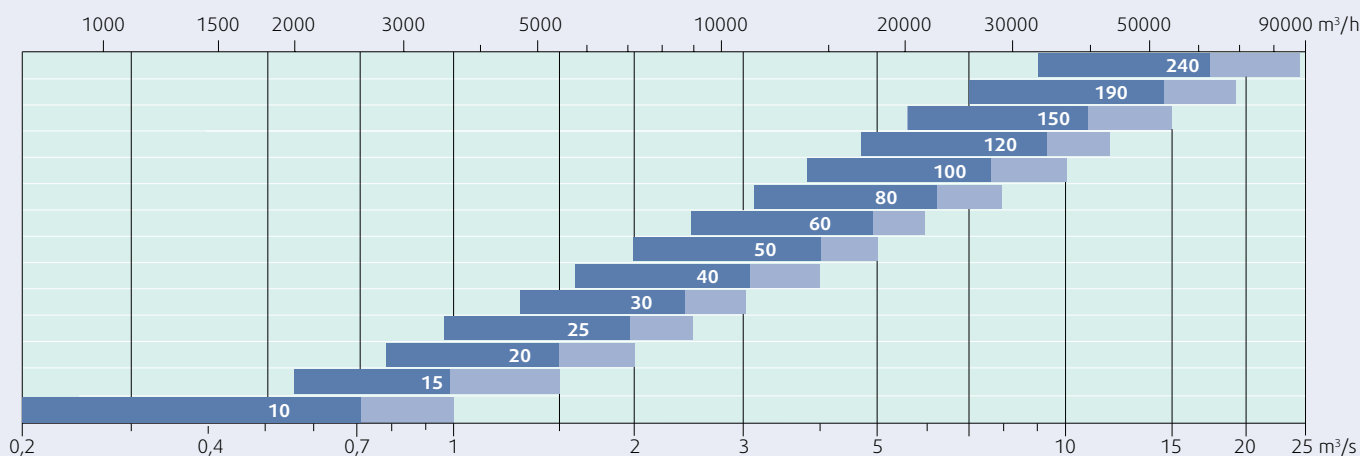

Indicates airflow range at the shown combination examples with heat recovery and by specific fan power 2,1 kW/(m³/s). The exact values are calculated by SystemairCAD.

Indicates airflow range for the unit size.



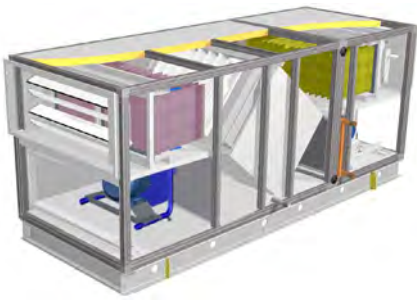

Frame profiles and corners

Danvent DV is constructed using a closed framing profile with cast painted aluminium corner pieces. The frame profiles are made of steel with alu-zinc corrosion protection. The result is a strong and robust construction able to resist twisting and lateral movement, making the unit extremely stable and strong.

Panels

The panels of the Danvent DV are built using a sandwich construction with double sheets and 50 mm mineral wool for sound and heat insulation. The mineral wool is completely encapsulated, since the panels are closed on all sides.

The panels with alu-zinc surface are not only highly corrosion-resistant, but present an attractive, uniform appearance that can last for many years. Steel sheets which are protected

with alu-zinc AZ185 ensure a corrosion protection in class C4 according to EN ISO 12944-2:2000.

Disc-Lock

An air handling unit consisting of several sections in size 10-150 can be quickly and efficiently assembled using Disc-Lock, our unique assembly system.

Inspection doors

Danvent DV has large inspection doors, making service access easy. The doors are mounted using solid hinges with easily removable stainless steel pins. This means that the doors can be easily removed, if there is no room for normal opening of the doors.

The doors are sealed using rubber profiles and locks with heavy-duty handles. They can only be opened using a key.

Roof units

Danvent DV in the sizes 10-150 are available as roof units, designed for outdoor installation. In this version the unit features a roof construction which together with the double sealing of the panels provides protection against the effects of the weather. The unit is available with louvers for air intake and exhaust.

Control system

Danvent DV is available with pre-installed and fully integrated Systemair Corrigo control system. Corrigo is an advanced user-friendly system, with an external remote control panel for all settings. The panel can be placed freely in the building. Corrigo is a modern control system with a large number of features e.g. alarms, setting of time, operating values and operating status. The system is prepared for communication to a BMS system.

Product Information

Air handling unit casing

Rigid frames with sound and thermal insulated panels.

Materials

Frames

Closed 1,3/1,5 mm steel profile.
Surface: Alu-zinc AZ 185.

Corners

Strong cast painted aluminium corner pieces.

Panels

Insulation sandwiched between two 0,8 mm steel sheets. The steel sheets are corrosion protected with alu-zinc AZ185.

Corrosion protection

Steel sheets which are protected with alu-zinc AZ 185 ensure a corrosion protection in class C4 according to the standard EN ISO 12944-2:2000.

Insulation

Sound and thermal insulating mineral wool, which is completely encapsulated between two steel sheets.

Thickness: 50 mm.

Density: 50 kg/m³.

Operating pressure

Difference between surrounding and pressure inside the air handling unit:

0 - 2000 Pa (DV 10-150)

0 - 1500 Pa (DV 190-240)

Operating temperatures

General temperatures

General temperatures for the air in the air handling unit:

Standard design: -40/+40 °C

Special design: -40/+60 °C

Classifications

The performance of the air handling unit casing corresponds with the following classifications according to the European standard EN 1886, 2. edition 2008.

Mechanical strength

Class D2

Casing air leakage

Negative pressure: - 400 Pa: Class L2

Positive pressure: + 700 Pa: Class L2

Filter by-pass leakage

Negative pressure:

- 400 Pa: Class G1-F9

Positive pressure:

+ 400 Pa: Class G1-F9

Thermal transmittance

Class T2

Thermal bridging factor

Class TB3

Acoustic insulation of casing

Octave band Hz	Insulation dB
125	17
250	23
500	24
1000	23
2000	25
4000	31
8000	38



Standards and Certifications

The Danvent DV design is based on the demands in the following CEN and ISO standards:

EN 305:1997

Heat exchangers. Definition and test procedures.

EN 308:1997

Heat exchangers. Test procedures.

EN 779:2012

Particulate air filters for general ventilation.

EN 1216:1999

Heat exchangers

EN 1751:2014

Aerodynamic testing of dampers and valves.

EN 1886:2008

Air handling units.
Mechanical performance.

EN 13053:2011

Ratings and performance for units and components.

EN 13779:2007

Ventilation for non-residential buildings. Performance requirements.

EN 60204-1:2006

Machine safety.
Electrical equipment of machines.

EN ISO 3741:2010

Determination of sound power level in reverberation rooms.

EN ISO 5136:2009

Determination of sound power level in a duct.

EN ISO 12100:2011

Safety of machinery.

EN ISO 12944-2:2000

Corrosion protection. Classification of environments.

Eurovent certification

Danvent DV air handling units are Eurovent certified. This ensures the conformity between the calculated performance in SystemairCAD design programme, and the measured performance at independent test laboratories. Certificate 07.02.339.

ISO 9001:2008 certification

Danvent DV air handling units are developed and manufactured in Denmark. The Quality management system at the factory is certified according to the standard EN ISO 9001:2008 by Bureau Veritas Certification.

Machinery directive





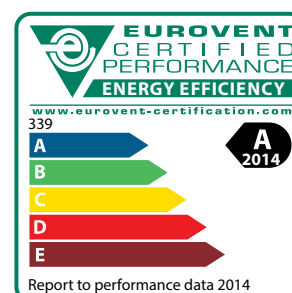

Danvent DV air handling units are manufactured according to the safety demands of the EU Machinery Directive 2006/42/EF. This is confirmed through the issuance of corresponding Declaration of Incorporation for units without unit control system, and corresponding Declaration of Conformity and CE label for units with factory installed unit control system.

Eurovent energy classification

Danvent DV air handling units are energy classified in according to Eurovent's guidelines for air handling units RS 6/C/005-2015. The energy class expresses the unit's total energy consumption. The energy class is calculated by the design programme SystemairCAD based on the actual data of the designed unit.







Combination Examples

Rotary heat exchanger		Unit size														
		10	15	20	25	30	40	50	60	80	100	120	150	190	240	
Unit	Width	970	1120	1270	1420	1570	1720	2020	2170	2170	2370	2590	2890	3190	3490	
Rotary heat exchanger section	Width	-	-	-	-	-	-	-	-	-	2320	2520	2890	3040	3720	4020
Unit	Height*	970	1120	1270	1420	1570	1720	2020	2240	2540	2840	3140	3440	4340	4940	
C1 	Length	2160	2160	2460	2460	2760	3060	2910	3280	3210	3960	4260	4560	5010	5530	
	Weight kg	430	520	660	760	920	1100	1470	1980	2140	2630	3250	3990	6290	7610	
C2 	Length	2910	2910	3210	3210	3510	3810	3660	4030	4030	4930	5230	5530	5980	6430	
	Weight kg	500	610	770	870	1080	1270	1690	2250	2470	3050	3890	4690	7220	8600	
C3 	Length	2680	2680	3130	3130	3430	3880	4030	4400	4400	5450	5900	6200	6430	7100	
	Weight kg	480	580	730	810	1010	1220	1700	2230	2480	3160	3870	4660	6870	8280	
C4 	Length	3430	3430	3880	3880	4180	4630	4780	5220	5220	6420	7020	7170	7400	8000	
	Weight kg	560	660	840	930	1180	1390	1930	2560	2830	3610	4560	5320	7790	9180	
C5 	Length	2680	2680	3130	3130	3430	3880	3730	4100	4100	5080	5380	5680	6430	7100	
	Weight kg	480	570	720	800	1010	1220	1630	2120	2330	2970	3620	4390	6860	8280	
C6 	Length	3430	3430	3880	3880	4180	4630	4480	4850	4850	6050	6350	6650	7400	8000	
	Weight kg	550	660	840	920	1180	1380	1850	2410	2670	3370	4280	5060	7790	9170	

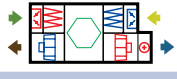
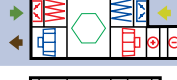
The above dimensions and weights are a guideline only. Accurate values and combinations are calculated in SystemairCAD.

* Height excl. legs/base frame. The heights of DV 190 and 240 are incl. base frames.

Plate heat exchanger Counterflow heat exchanger		Unit size						
		10	15	20	25	30	40	50
Unit	Width	970	1120	1270	1420	1570	1720	2020
Unit	Height*	970	1120	1270	1420	1570	1720	2020
Q1 	Length	3280	3430	3880	3880	4480	4780	4930
	Weight kg	570	700	874	1003	1296	1508	2084
Q2 	Length	3890	4180	4630	4630	5230	5530	5680
	Weight kg	660	790	1000	1140	1470	1680	2310
Q3 	Length	3730	3950	4550	4550	5150	5600	5750
	Weight kg	650	760	970	1020	1400	1630	2270
Q4 	Length	4480	4700	5300	5300	5900	6350	6500
	Weight kg	720	840	1080	1190	1560	1800	2510
Q5 	Length	3730	3950	4550	4550	5150	5600	5750
	Weight kg	640	750	960	1050	1410	1450	2250
Q6 	Length	4480	4700	5300	5300	5900	6350	6500
	Weight kg	720	840	1080	1180	1550	1790	2490

The above dimensions and weights are a guideline only. Accurate values and combinations are calculated in SystemairCAD.* Height excl. legs/base frame.

Design an air handling unit

Danvent DV contains countless combination options. To ease the process of designing a unit the most popular combinations are illustrated here.

Short building length

Choose EC blue fan if a short air handling unit is needed.

Key to symbols









- Exhaust air 
- Extract air 
- Outdoor air 
- Supply air 

Plate heat exchanger Cross-flow exchanger		Unit size											
		10	15	20	25	30	40	50	60	80	100	120	150
Unit	Width	970	1120	1270	1420	1570	1720	2020	2170	2170	2370	2590	2890
Unit	Height*	970	1120	1270	1420	1570	1720	2020	2240	2540	2840	3140	3440
Q1 	Length	3210	3580	4030	4330	4780	5080	5230	5460	5230	5910	6960	7260
	Weight kg	570	760	940	1130	1370	1640	2300	2550	2610	3210	4200	5130
Q2 	Length	3960	4330	4780	5080	5530	5830	5980	6210	5980	6880	7930	8230
	Weight kg	660	850	1060	1260	1540	1810	2520	2880	2910	3660	4870	5790
Q3 	Length	3800	4100	4700	5000	5450	5900	6050	6280	6280	7330	8380	8680
	Weight kg	650	820	1030	1140	1470	1760	2480	2720	2840	3620	4600	5550
Q4 	Length	4550	4850	5450	5750	6200	6650	6800	7030	6800	8000	9050	9350
	Weight kg	720	900	1140	1310	1630	1930	2720	3030	3130	3980	5150	6130
Q5 	Length	3800	4100	4700	5000	5450	5900	6050	6280	6130	7030	8080	8680
	Weight kg	640	810	1020	1170	1480	1750	2460	2700	2890	3690	4690	5840
Q6 	Length	4550	4850	5450	5750	6200	6650	6800	7100	6800	8000	9050	9350
	Weight kg	720	900	1140	1300	1620	1920	2700	3030	3200	4120	5320	6380

The above dimensions and weights are a guideline only. Accurate values and combinations are calculated in SystemairCAD.

* Height excl. legs/base frame.

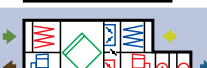
Run-around coil heat exchangers		Unit size													
		10	15	20	25	30	40	50	60	80	100	120	150	190	240
Unit	Width	970	1120	1270	1420	1570	1720	2020	2170	2170	2370	2590	2890	3190	3490
Single height unit	Height*	520	595	670	745	820	895	1045	1120	1270	1420	1570	1720	2170	2470
Double height unit	Height*	1040	1190	1340	1490	1640	1790	2090	2240	2540	2840	3140	3440	4340	4940
R1 	Length	2540	2540	2690	2690	2840	2990	2990	3140	3140	3590	3890	4110	5010	5230
	Weight kg	580	700	840	990	1170	1420	1980	2240	2460	2990	3800	4580	6290	7420
R2 	Length	3360	3360	3510	3510	3360	3810	3810	3960	3960	4560	4860	5010	5910	6060
	Weight kg	680	820	980	1150	1360	1620	2220	2550	2790	3510	4340	5170	7050	8270

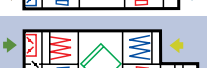
The above dimensions and weights are a guideline only. Accurate values and combinations are calculated in SystemairCAD.

* Height excl. legs/base frame. The heights of DV 190 and 240 are incl. base frames.

Integrated reversible heat pump		Unit size								
		10	15	20	25	30	40	50	60	80
Unit	Width	970	1120	1270	1420	1570	1720	2020	2170	2170
Rotary heat exchanger section	Width	-	-	-	-	-	-	-	-	2320
Unit	Height*	970	1120	1270	1420	1570	1720	2020	2240	2540
U1 	Length	3280	3280	3280	3580	3730	4030	5080	5150	5450
	Weight kg	550	650	1040	1290	1460	1780	2700	3460	3870

The above dimensions and weights are a guideline only. Accurate values and combinations are calculated in SystemairCAD.



* Height excl. legs/base frame.

Combination Examples

Recirculated air		Unit size													
		10	15	20	25	30	40	50	60	80	100	120	150	190	240
Unit	Width	970	1120	1270	1420	1570	1720	2020	2170	2170	2370	2590	2890	3190	3490
Single height unit	Height*	520	595	670	745	820	895	1045	1120	1270	1420	1570	1720	2170	2470
Double height unit	Height*	970	1120	1270	1420	1570	1720	2020	2240	2540	2840	3140	3440	4340	4940
M1 	Length	2240	2240	2390	2390	2540	2840	2690	2840	2990	3660	3810	3960	4410	5080
	Weight kg	250	280	350	390	470	560	800	900	1000	1300	1560	1900	2320	3040
M2 	Length	3060	3060	3210	3210	3360	3660	3510	3660	3810	4410	4560	4710	5380	5980
	Weight kg	330	400	480	560	640	780	1050	1180	1320	1660	2140	2460	3250	3940
M3 	Length	3580	3580	3880	3880	4180	4780	4480	4780	5080	5980	6350	6650	7550	8820
	Weight kg	390	450	560	620	760	940	1270	1470	1630	2060	2660	3150	3930	5100
M4 	Length	4400	4400	4700	4700	5000	5600	5300	5600	5900	6950	7250	7620	8520	9720
	Weight kg	480	560	690	790	940	1150	1550	1760	1960	2530	3250	3800	4850	6000
M5 	Length	2610	2610	2910	2910	3210	3660	3360	2990	2990	3590	3810	3960	4710	5080
	Weight kg	360	430	530	580	750	910	1220	1360	1520	1950	2510	2990	4190	5150
M6 	Length	3430	3430	3730	3730	4030	4480	4180	3810	3880	4630	4780	4860	5680	5980
	Weight kg	460	540	670	730	930	1150	1480	1650	1880	2430	3150	3570	5110	6050

The above dimensions and weights are a guideline only. Accurate values and combinations are calculated in SystemairCAD.





* Height excl. legs/base frame. The heights of DV 190 and 240 are incl. base frames.

Supply air		Unit size													
		10	15	20	25	30	40	50	60	80	100	120	150	190	240
Unit	Width	970	1120	1270	1420	1570	1720	2020	2170	2170	2370	2590	2890	3190	3490
Single height unit	Height*	520	595	670	745	820	895	1045	1120	1270	1420	1570	1720	2170	2470
Double height unit	Height*	1040	1190	1340	1490	1640	1790	2090	2240	2540	2840	3140	3440	4340	4940
S1 	Length	1940	1940	2090	2090	2240	2390	2240	2390	2390	2690	2990	3140	4040	4260
	Weight kg	220	260	320	370	430	510	700	800	880	1100	1400	1700	2250	2820
S2 	Length	2690	2690	2840	2840	2990	3140	2990	3140	3140	3590	3960	4110	5010	5160
	Weight kg	310	370	450	520	620	730	960	1110	1230	1490	2020	2320	3170	3720
S3 	Length	1940	1940	2090	2090	2240	2390	2240	2390	2390	2690	2990	3140	4040	4260
	Weight kg	340	400	500	580	690	830	1140	1320	1440	1790	2350	2800	3690	4560
S4 	Length	2690	2690	2840	2340	2990	3140	2990	3140	3140	3590	3960	4110	5010	5160
	Weight kg	430	510	630	730	870	1040	1400	1630	1790	2180	2960	3410	4610	5460

The above dimensions and weights are a guideline only. Accurate values and combinations are calculated in SystemairCAD.

* Height excl. legs/base frame. The heights of DV 190 and 240 are incl. base frames.

Key to symbols

- Exhaust air 
- Outdoor air 
- Extract air 
- Supply air 

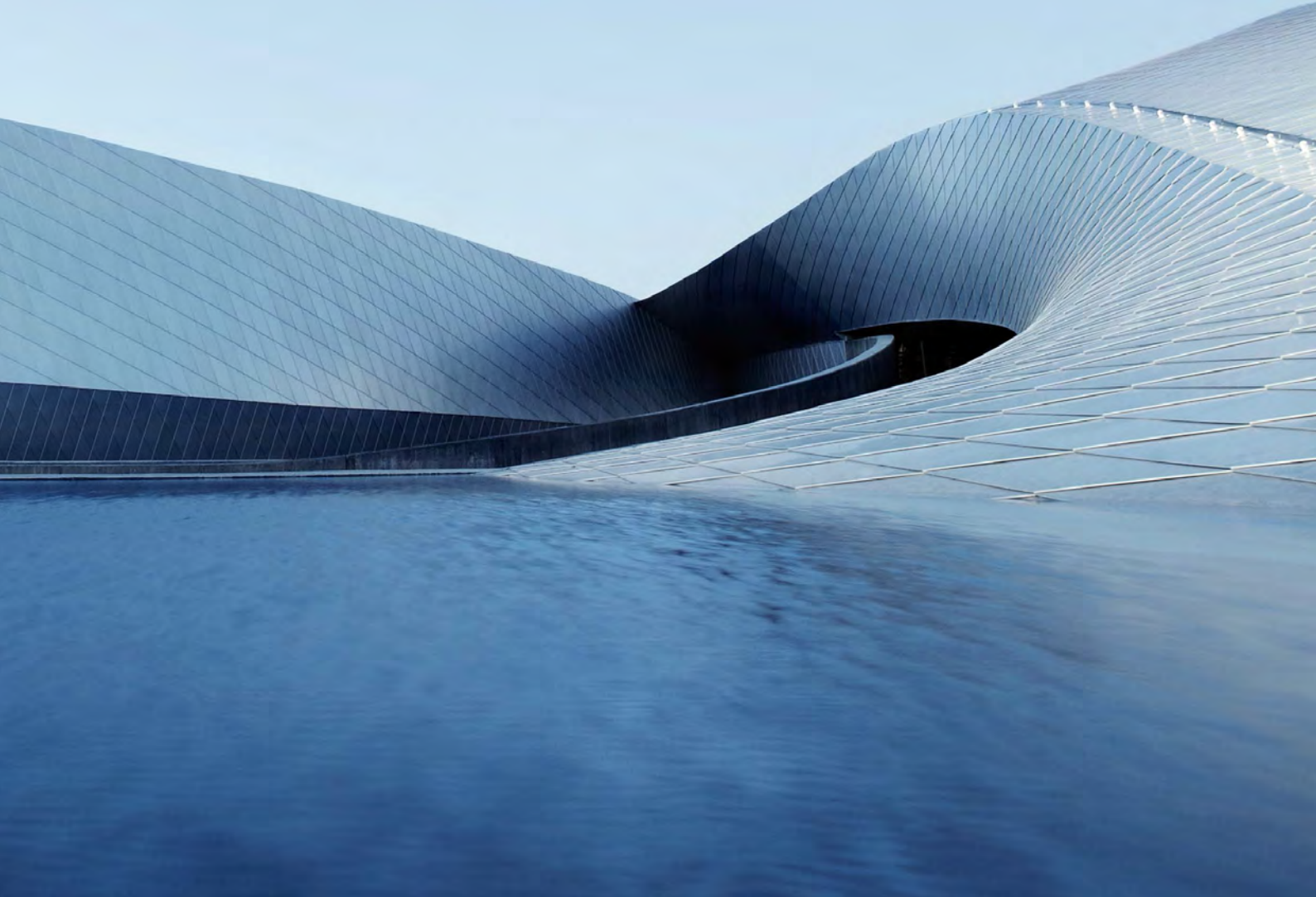



Damper DVA



Mixing damper DVM

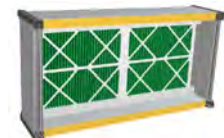

Compact filter DVG



Damper DVB



Mixing damper DVP



Bag filter DVF

Functions

Dampers

The dampers used in Danvent DV comply with EN 1751:2014, sealing class 3. They have contra-rotating aerodynamically formed aluminium blades that ensure a low pressure loss when open.

The blades are equipped with special rubber sealing strips between the blades themselves and the frame, to prevent air getting in. For very cold areas, the blades can be insulated.

The dampers ensure a long and trouble-free operation, as the blades are mounted on sturdy square profile shafts and service-free synthetic bearings with large bearing surfaces. A pivoting system placed outside the airflow connects the blades, and it is fitted with brass bushings. This all-metal solution of the pivoting system ensures dampers smooth operation even in areas with extreme cold. The dampers are fitted with a position indicator.

Damper DVA

DVA is a shutoff damper designed for efficient closing off of the supply and exhaust air. The damper is to be placed inside the unit and is prepared for internal damper motor. *Read more, page 20.*

Damper DVB

DVB is a shutoff damper fitted at the top of the unit, and is used where a damper is required for vertical air handling unit connection. Prepared for internal damper motor. *Read more, page 22.*

Mixing damper DVM

DVM is a mixing damper with two built-in dampers that can either be used as a shutoff or recirculation damper. Prepared for internal damper motors. When combined with the DVB damper, the DVM acts as a total mixing system, also ideal for recirculation. *Read more, page 24.*

Mixing damper DVP

DVP is a complete mixing damper with three built-in dampers, which can either be used as shutoff or recirculation dampers. Prepared for internal damper motors. *Read more, page 26.*

Compact filter DVG

DVG is a compact basic filter class G4 according to EN 779:2012. It has a very short built-in length but DVG has a relatively large filter area due to the pleated filter construction. This gives the DVG filter a relatively low pressure loss and long lifetime. DVG is ideal as a pre-filter, helping to prolong the lifetime of the main filter. The DVG filter can be slotted into the filter frame of the air handling unit. *Read more, page 28.*

Bag filter DVF

DVF's special shape provides an extremely large filter area, which together with the filter material's unique ability to collect dust particles, ensure that the DVF filter has a long lifetime, making it economical. DVF filter is composed of filter cells classes G4, M5, M6, F7, F8, F9 and F7 City-Flo according to EN 779:2012.

F7 City-Flo is a filter with particle and molecular filtration in the same media. This unique filter media has a very low initial and average pressure drop during its life time. Several global standards require this kind of filtering solution in urban areas and areas with heavy traffic.

DVF 10-150: The filter cells are held in place using a simple but effective system of lateral locking rails with large handles, making filter changing quick and easy.

DVF 190-240: The filter cells are held in place to the filter bank frames with effective fasteners.

This system also ensures that the filter cells form a tight seal with the unit frame to comply with EN 1886:2008 edition. All seals are fixed to the unit and do not need replacement when installing new filters. Filter cells from all major filter manufacturers can be used in the DVF unit. *Read more, page 30.*



Rotary heat exchanger DVC



Plate heat exchanger DVQ

Rotary Heat Exchanger DVC

DVC is a rotary heat exchanger with a high level of efficiency that can also be used to transfer moisture from warm and humid extract air. This type of heat exchanger is one of the most efficient of the various heat exchanger systems. It is also the most compact, due to its short installation length.

DVC is available in 4 versions with different maximum efficiencies from 75 to 87% depending on operating conditions.

DVC is available in 3 variants: Standard, enthalpy and sorption heat exchanger.

Standard heat exchangers recover heat from extract air and contribute to the heating of the supply air. At low outdoor temperatures it can also transfer moisture from the condensing extract air. It is available in all 4 versions.

Enthalpy heat exchangers recover heat and moisture from extract air, and contribute to heating and humidification of the supply air. It is available in 3 versions.

A sorption heat exchanger is ideal for climate with high summer temperature and humidity, where it can achieve significant savings by dehumidifying of the outdoor air before cooling. It is available in 2 versions.

The DVC consists of a rotor made of corrugated aluminium, built-in to stable rotor housing with a large inspection door. The rotor is assembled on rails up to size 40, enabling it to be pulled out for inspection and service. To minimize air leakage, DVC heat exchangers are fitted with highly efficient brush seals between the housing and the rotor. The rotor's drive unit is factory-fitted and can be used for both constant and variable speed. Variable speed gives a stepless regulation of the speed and thus an optimal control of the heat recovery. *Read more, page 32.*

Plate Heat Exchanger DVQ

DVQ is a plate heat exchanger available in 3 versions. Cross flow heat exchanger for unit sizes 10 to 150 in standard version with efficiency up to 65%, in high efficiency version with efficiency up to 75%, and counter flow heat exchanger for unit sizes 10

to 50 with efficiency up to 90%, depending on operating conditions. DVQ is thus ideal for situations where the separation of the two airflows is a necessity, to avoid the transfer of unpleasant odours to the supply air for example. Because humidity is not transferred between the airflows, DVQ can also be used for dehumidifying.

The cross flow heat exchanger is available in two variants for use in different environments. The aluminium variant is used for commercial ventilation where no corrosive elements are present in the air, such as schools, kindergartens, offices, airports and hotels. The corrosion resistant variant with coated aluminium plates is used in environments where the extract air can contain aggressive elements. The counter flow heat exchanger version is only available in aluminium variant. The heat transfer capacity can be regulated using the built-in by-pass damper. Cross flow versions are always fitted with a drip tray to collect condensed water from the extract air. The counter flow versions have drip tray fitted in both extract and supply air. *Read more, page 36.*

Functions

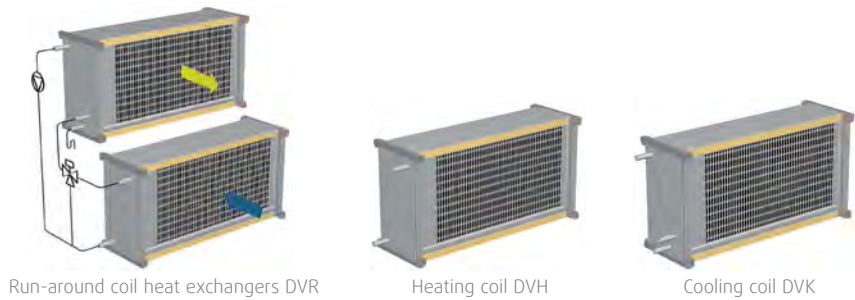

Run-around coil heat exchangers DVR

Heating coil DVH

Cooling coil DVK

Run-around coil heat exchangers DVR

DVR is a heat exchanger system where a mixture of water and glycol is circulated between a heating coil in the supply airflow and a cooling coil in the extract airflow. The transfer of heat takes place via a piped circuit that must be fitted after the unit is installed.

DVR heat exchangers have an efficiency of up to 70%. The effectiveness of the system is dependent on its construction and the volume and type of water/glycol mixture circulating between the coils. Run-around coil heat exchangers are used where the two airflows must be kept completely separate, or where they are at a distance from each other e.g. on two different storeys of a building. A drip tray is fitted in the extract air coil section. The drain outlet must be connected to a water trap with sufficient locking height. The extract air coil can be supplied with a built-in droplet eliminator. DVR has coils made of copper tubes with aluminium fins. Capacity regulation can be achieved using a shunt system with a motor valve, or by regulating the circulation pump. *Read more, page 40.*

Heating coil DVH

The DVH heating coil is used to heat up the supply air, using either hot water, condensation of a cooling medium or electricity. Dimensioning the DVH coil is done using the design programme SystemairCAD, where the coil will be determined optimally to solve the current task. SystemairCAD calculations are TÜV tested according to EN 1216:1999.

Heating coils are manufactured of materials adapted to the heating medium and the environment the coil is to operate in. Coils with copper tubes and aluminium fins are used for hot water and condensation. The copper tubes are $\varnothing 10$ or $\varnothing 15$ mm, depending on the capacity required. Electrical heating coils have stainless steel heating elements and built-in safety control system.

As light corrosion protection the heating coils can be supplied with fins in aluminium-magnesium or epoxy coated aluminium. Coils for hot water can be supplied with a connection piece to fit a temperature sensor in the water circuit, in order to subsequently equip the unit with modulating frost protection. The coil is fully built-in in the unit as standard, but also comes in a MAX version where the coil section is wider than the standard unit width. This will reduce the air velocity. *Read more, page 42.*

Cooling coil DVK

The DVK cooling coil is used to cool down the supply air either with cold water, or directly evaporation. Dimensioning the DVK coil is done using the design programme SystemairCAD, where the coil will be determined optimally to solve the current task. SystemairCAD calculations are TÜV tested according to EN 1216:1999.

DVK coils are made with copper tubes and aluminium fins. The tubes are $\varnothing 10$ or $\varnothing 15$ mm, depending on the capacity required. As light corrosion protection the cooling coils can be supplied with fins in aluminium-magnesium or epoxy coated aluminium.

Cooling coils for direct evaporation have the liquid distributor located in the unit. The expansion valve can be fitted on the connection pipe outside the unit. Cooling coils are fitted with drip tray. The drain outlet must be connected to a water trap with sufficient locking height. The cooling coil can be supplied with a built-in droplet eliminator. The coil is fully built-in in the unit as standard, but also comes in a MAX version where the coil section is wider than the standard unit width. This will reduce the air velocity. *Read more, page 44.*



Heat pump DVU-HP

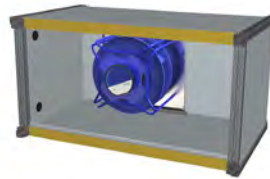

Plug fan DVE-EC Blue

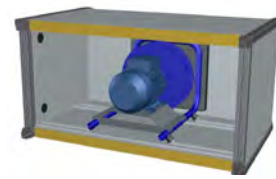

Plug fan DVE-PM/AC

Change-over coil DVHK

Change over coil DVHK is basically a cooling coil for cold water that can be used also for heating by changing the water temperature from cold to hot depending on the demand. Typically, it is used in connection with heat pumps. The coil is dimensioned in SystemairCAD so it can meet the capacity requirements for both heating and cooling. *Read more, page 46.*

Heat pump DVU-HP

DVU-HP is a complete section with an integrated heat pump system with the option of both heating and cooling. It also includes a rotary heat exchanger for efficient heat and cooling recovery. The section is supplied built into Danvent DV and is tested from the factory ready for operation. The combination of heat pump and rotary heat exchanger ensures a short installation length and excellent operating economy in both heating and cooling situations. DVU-HP is equipped with two scroll compressors (1 compressor for DV 10 and DV 15), and heating/cooling capacity is stepless variable in the range 5-100% for maximum comfort and minimum energy consumption. The heat pump is based on R-410A refrigerant.

DVU-HP is delivered with built-in control system for complete control and management of the refrigeration system. DVU-HP's intelligent control

system communicates with the air handling unit's control system, so that the desired heating or cooling capacity is always delivered. When heating or cooling is required, the heat pump will start, and the capacity is controlled through the modulating digital function on one of the scroll compressors. The built-in control system in the DVU-HP also ensures that compressors and other components always work within the permitted limits and thus do not get overloaded. Airflow and temperature are controlled by the control system of the air handling unit. *Read more, page 48.*

Plug fan DVE

The DVE has the fan impeller fitted directly to the motor, and enclosed into an acoustically insulated casing.

A plug fan is a single inlet, freeblowing fan, where the unit casing functions as fan housing. The fan has an efficiency of up to 75% and features low sound levels in the low frequencies. In order to optimize the fan efficiency a number of larger units are equipped with more fans for parallel operating.

Because of its construction, a plug fan can give a low and even air speed at the outlet of the fan unit. The DVE is ideal for units where components are to be positioned after the fan.

In order to make service and inspection access easy, the DVE is fitted with a large hinged inspection door with a safety guard behind the door. Interior lighting is an option.

DVE comes in two variants:

- **DVE-EC Blue**

Compact plug fan with an effective composite impeller, and EC external rotor motor with integrated variable speed control. The EC motor is in efficiency class IE4.

- **DVE-PM/AC**

Plug fan with an effective impeller fitted to the motor shaft. Depending on size the impeller is made of composite material or painted steel. The fan can be supplied with 2 types of motors:

- Highly efficient PM synchronous motor, efficiency class IE4.
- AC asynchronous motor, efficiency class IE2.

PM and AC motors are stepless controllable via frequency converter.

In order to optimize the plug fan efficiency in the operating point, the fans can be selected in more variants in each unit size.

All impellers are balanced statically and dynamically. PM/AC plug fans are mounted on vibration isolators to ensure vibration-free operation.

Read more, page 52.

Functions



Sound attenuator DVD



Inspection section DVI



Empty section DVO

Sound attenuator DVD

The DVD is an absorption sound attenuator, fitted with baffles. DVD is used to reduce the sound power level from the air handling unit to the duct system.

For environmental reasons, the baffles have a surface lining that effectively prevents the entrainment of the sound-absorbing material. This surface lining comes in two variants:

1. Standard lining, suitable for all forms of comfort ventilation purposes. Baffles with a strongly, durable lining, resistant to mecha-

nical wear and tear. Are used in situations where the baffles require dry cleaning, such as brushing or vacuum cleaning.

2. Baffles with a synthetic lining, ideal for wet cleaning. Each baffle is enclosed in a stainless steel frame and used where high levels of hygiene require direct washing of the baffles.

DVD can be variant 1, as an option, be delivered with large inspection doors for easy cleaning. Inspection doors are standard by variant 2. *Read more, page 56.*

Inspection Section DVI

The DVI inspection section is an empty unit section with an inspection door. DVI is used between components that require inspection and servicing. DVI can be fitted with an inspection window and internal light. *Read more, page 58.*

Empty section DVO

DVO is an empty unit section without inspection door. Can e.g. be used to create distance between unit components with different shapes. *Read more, page 59.*



Roof unit DV
Bitumen roof



Roof unit DV
Steel profile roof



DSP control panel

Roof unit DV

The DV air handling unit in the sizes 10 to 150 are available as roof units for outdoor installation. In this version the unit is assembled on a base frame and features a roof construction which together with the double sealing of the panels provides protection against the effects of the weather.

The DV roof unit can be delivered with two different types of roofing:

Bitumen roof:

Manufactured of polyester, reinforced bitumen material fitted to the unit by a heating process. The bitumen roof is a very close and robust roofing completely finished from factory.

Steel profile roof:

Manufactured of alu-zink protected, corrugated steel sheets, and profiles

for fastening and finishing the roofing. This type of roofing is supplied for local assembling on the air handling unit. The steel profile roof is a robust roofing where the surface matches the units panels.

Air intake and exhaust are available with louvers for effective protection against rain and snow. Outdoor air section DVY (see page 60) features outlet of exhaust air on the back of the unit.

Systemair Corrigo control system

Danvent DV is available with pre-installed Systemair Corrigo control system, fully tested at the factory. It is a flexible and user-friendly system, where operating and monitoring is carried out on a remote control panel, which can be positioned freely up to 100 m from the unit.

The control panel displays continuously operating status, operating values, time settings and alarms. The control system is supplied preinstalled with the functions selected in the design programme SystemairCAD and with standard temperature, time settings and control sequences so that it is ready for use immediately after installation.

Additions or changes to functions can be made via the control panel. The Corrigo can communicate with BMS systems via Modbus, Bacnet or Lon. Operation can alternatively be managed via WEB interface or an Android application.

Damper DVA



Function

Supply or extract air shutoff damper.

Air tightness classification

Class 3 according to EN 1751:2014.

Damper blades

Aerodynamically formed aluminium profiles. Can be supplied as an option:

- Insulated
- Anodized.

Bearings

Synthetic bearings with large bearing surfaces.

Sealing

Rubber sealing strips between the damper blades. Special sealing between frame and damper blades.

Shafts



14,3 mm aluminium



16,3 mm aluminium with steel reinforcement

Blade pivoting system

Steel rods with maintenance free brass bushings.

Blade position indicator

Arrow for indication of the blade position.

Motor bracket

Bracket for fixing of a damper motor for each damper.

Damper motor

The dampers are activated by a motor for each damper.

DV 10-150: 1 damper motor.

DV 190-240: 2 damper motors.



Damper fitted to the upper part of a double height unit



Damper fitted to a single height unit

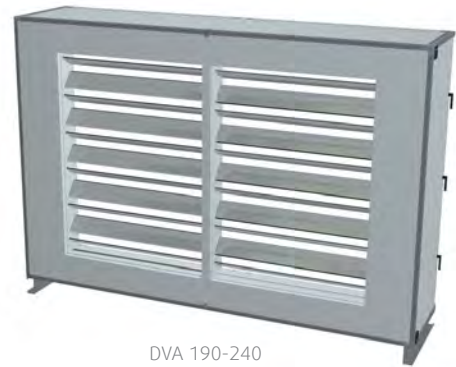

DVA 190-240

DVA 10-150

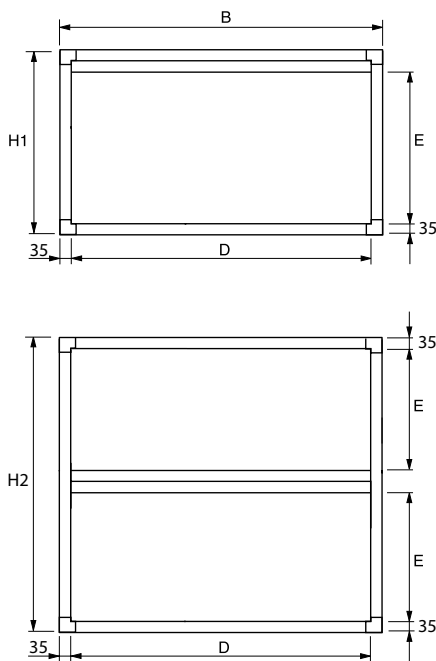

H1: Single height unit
H2: Double height unit

DVA 190-240

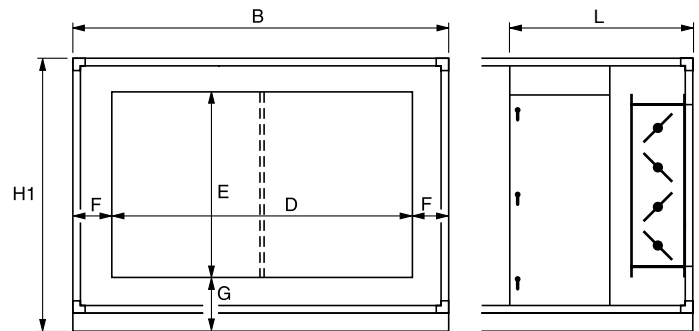

Dimensions

Size	10	15	20	25	30	40	50	60	80	100	120	150	190	240
B	970	1120	1270	1420	1570	1720	2020	2170	2170	2370	2590	2890	3190	3490
H1	520	595	670	745	820	895	1045	1120	1270	1420	1570	1720	2170	2470
H2	970	1120	1270	1420	1570	1720	2020	-	-	-	-	-	-	-
L	185	185	185	185	185	185	185	185	185	185	335	335	785	785
D	900	1050	1200	1350	1500	1650	1950	2100	2100	2300	2520	2820	2600	2800
E	350	450	500	600	650	750	900	1000	1150	1300	1450	1600	1500	1800
F	-	-	-	-	-	-	-	-	-	-	-	-	295	345
G	-	-	-	-	-	-	-	-	-	-	-	-	410	410

Torque (Nm) for each damper

Size	10	15	20	25	30	40	50	60	80	100	120	150	190	240
0 Pa	4	5	6	7	8	9	11	12	14	15	17	18	2*12	2*15
500 Pa	7	8	10	11	13	14	16	17	19	21	23	24	2*17	2*21
1000 Pa	9	11	13	15	17	19	20	22	24	26	28	29	2*22	2*26

Required minimum torque per damper motor for opening/closing at varying differential pressure across the damper.

Damper DVB



Function

Extract air shutoff damper.

Air tightness classification

Class 3 according to EN 1751:2014.

Damper blades

Aerodynamically formed aluminium profiles. Can be supplied as an option:

- Insulated
- Anodized.

Bearings

Synthetic bearings with large bearing surfaces.

Shafts



14,3 mm
aluminium



16,3 mm aluminium
with steel reinforcement

Sealing

Rubber sealing strips between the damper blades. Special sealing between frame and damper blades.

Blade pivoting system

Steel rods with maintenance free brass bushings.

Blade position indicator

Arrow for indication of the blade position.

Motor bracket

Bracket for fixing of a damper motor for each damper.

Damper motor

The dampers are activated by a motor for each damper.

DV 10-150: 1 damper motor.

DV 190-240: 2 damper motors.



DVB 10-150



DVB 190-240

DVB 10-150

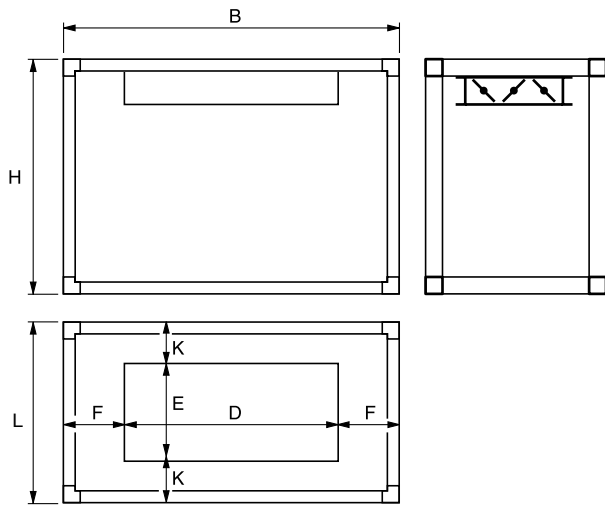

DVB 190-240

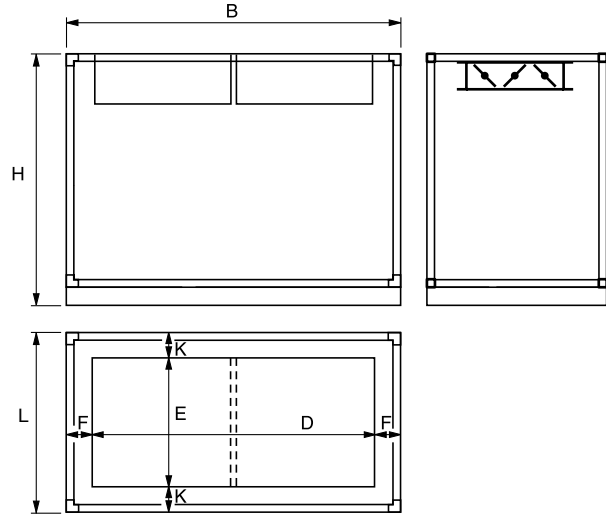

Dimensions

Size	10	15	20	25	30	40	50	60	80	100	120	150	190	240
B	970	1120	1270	1420	1570	1720	2020	2170	2170	2370	2590	2890	3190	3490
H	520	595	670	745	820	895	1045	1120	1270	1420	1570	1720	2170	2470
L	520	520	520	520	520	670	670	670	820	970	970	970	1120	1570
D	500	600	800	900	1100	1200	1500	1600	1700	1800	2000	2300	2600	2800
E	200	200	300	300	300	400	400	500	600	700	700	700	1000	1200
F	235	260	235	260	235	260	260	285	235	285	295	295	295	345
K	160	160	110	110	110	135	135	85	110	135	135	135	60	185

Torque (Nm) for each damper

Size	10	15	20	25	30	40	50	60	80	100	120	150	190	240
0 Pa	4	4	4	5	6	7	8	9	10	11	13	14	2*10	2*12
500 Pa	5	6	7	8	10	11	13	14	15	16	18	19	2*15	2*17
1000 Pa	7	8	9	11	13	15	17	19	20	20	23	24	2*20	2*22

Required minimum torque per damper motor for opening/closing at varying differential pressure across the damper.

Mixing Damper DVM



Function

Supply air shutoff and mixing damper.

Air tightness classification

Class 3 according to EN 1751:2014.

Damper blades

Aerodynamically formed aluminium profiles. Can be supplied as an option:

- Insulated
- Anodized.

Bearings

Synthetic bearings with large bearing surfaces.

Shafts



14,3 mm aluminium



16,3 mm aluminium with steel reinforcement

Sealing

Rubber sealing strips between the damper blades. Special sealing between frame and damper blades.

Blade pivoting system

Steel rods with maintenance free brass bushings.

Blade position indicator

Arrow for indication of the blade position for each damper.

Motor bracket

Bracket for fixing of a damper motor for each damper.

Damper motor

The dampers are activated by a motor for each damper.

DV 10-150: 2 damper motors.

DV 190-240: 4 damper motors.

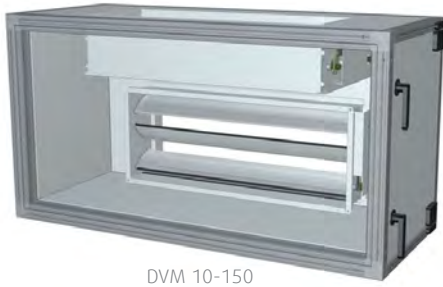

DVM 10-150

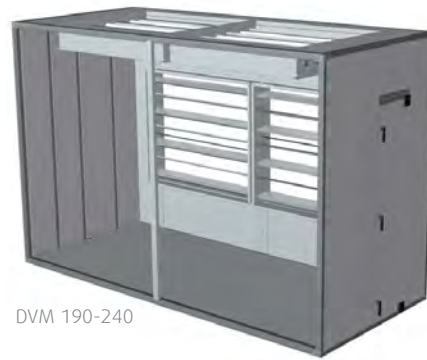

DVM 190-240

DVM 10-150

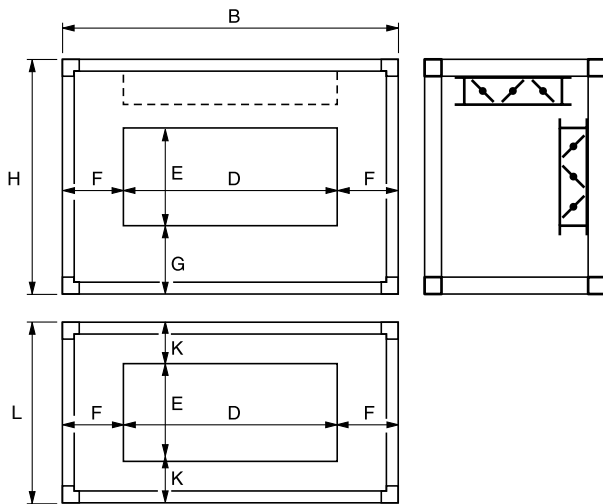

DVM 190-240

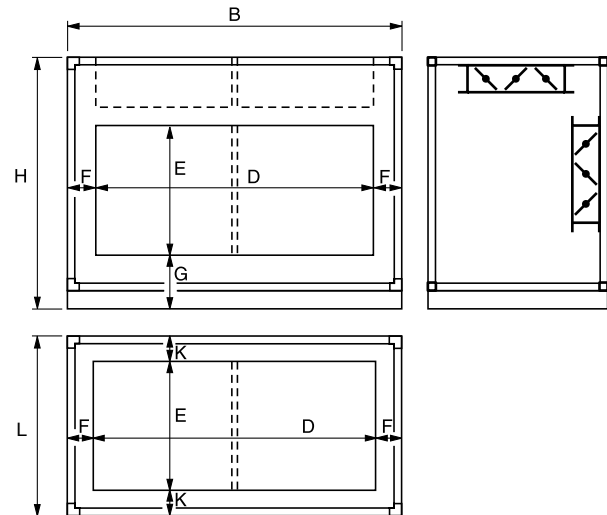

Dimensions

Size	10	15	20	25	30	40	50	60	80	100	120	150	190	240
B	970	1120	1270	1420	1570	1720	2020	2170	2170	2370	2590	2890	3190	3490
H	520	595	670	745	820	895	1045	1120	1270	1420	1570	1720	2170	2470
L	520	520	520	520	520	670	670	670	820	970	970	970	1120	1570
D	500	600	800	900	1100	1200	1500	1600	1700	1800	2000	2300	2600	2800
E	200	200	300	300	300	400	400	500	600	700	700	700	1000	1200
F	235	260	235	260	235	260	260	285	235	285	295	295	295	345
G	100	100	100	100	100	100	100	100	100	100	100	100	660	710
K	160	160	110	110	110	135	135	85	110	135	135	135	60	185

Torque (Nm) for each damper

Size	10	15	20	25	30	40	50	60	80	100	120	150	190	240
0 Pa	4	4	4	5	6	7	8	9	10	11	13	14	2*10	2*12
500 Pa	5	6	7	8	10	11	13	14	15	16	18	19	2*15	2*17
1000 Pa	7	8	9	11	13	15	17	19	20	20	23	24	2*20	2*22

Required minimum torque per damper motor for opening/closing at varying differential pressure across the damper.

Mixing Damper DVP



Function

Supply, extract air shutoff and mixing damper.

Air tightness classification

Class 3 according to EN 1751:2014.

Damper blades

Aerodynamically formed aluminium profiles. Can be supplied as an option:

- Insulated
- Anodized.

Bearings

Synthetic bearings with large bearing surfaces.

Shafts



14,3 mm aluminium



16,3 mm aluminium with steel reinforcement

Sealing

Rubber sealing strips between the damper blades. Special sealing between frame and damper blades.

Blade pivoting system

Steel rods with maintenance free brass bushings.

Blade position indicator

Arrow for indication of the blade position for each damper.

Motor bracket

Bracket for fixing of a damper motor for each damper.

Damper motor

The dampers are activated by a motor for each damper.

DV 10-150: 3 damper motors.

DV 190-240: 6 damper motors.

Transport

DV 10 - DV 50:

Delivered at full height. Transport height HT minimum = H.

DV 60 - DV 150:

Delivered as standard at full height.

Transport height HT minimum = H.

Available as an option divided into transport height HT minimum = H/2.

DV 190 - DV 240:

Is always delivered divided into 2 sections. Transport height HT minimum = H/2.



DVP 10-150

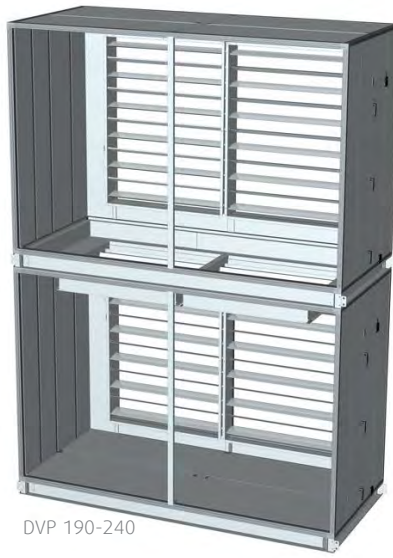

DVP 190-240

DVP 10-150

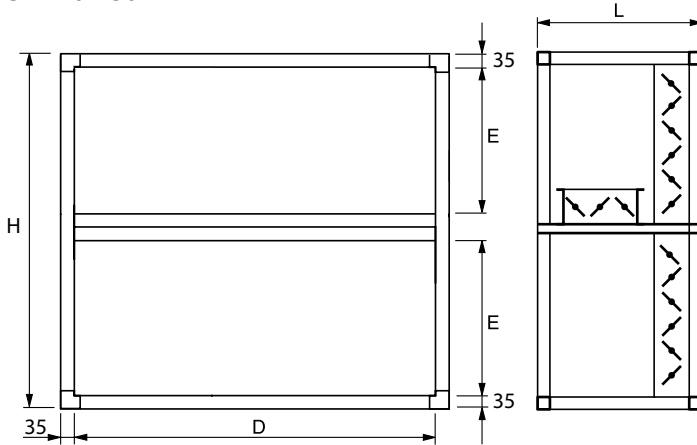

DVP 190-240

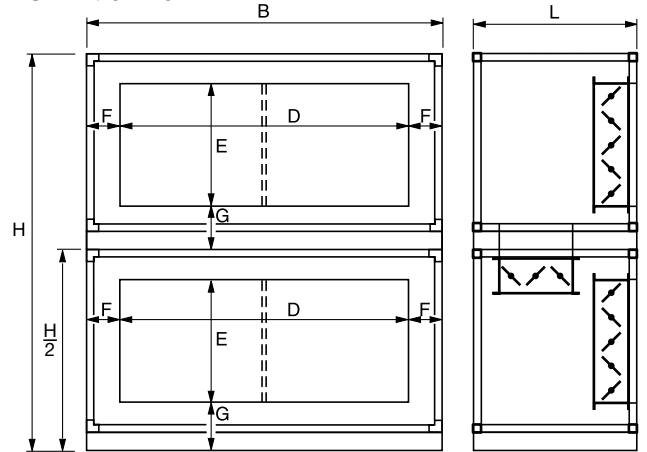

DVP 190 and 240 is divided into two sections at delivery.

Dimensions

Size	10	15	20	25	30	40	50	60	80	100	120	150	190	240
B	970	1120	1270	1420	1570	1720	2020	2170	2170	2370	2590	2890	3190	3490
H	970	1120	1270	1420	1570	1720	2020	2240	2540	2840	3140	3440	4340	4940
L	520	520	670	670	670	820	820	970	970	1120	1120	1120	1420	1570
D	900	1050	1200	1350	1500	1650	1950	2100	2100	2300	2520	2820	2600	2800
E	350	450	500	600	650	750	900	1000	1150	1300	1450	1600	1500	1800
F	-	-	-	-	-	-	-	-	-	-	-	-	295	345
G	-	-	-	-	-	-	-	-	-	-	-	-	410	410

Torque (Nm) for each damper

Size	10	15	20	25	30	40	50	60	80	100	120	150	190	240
0 Pa	4	5	6	7	8	9	11	12	14	15	17	18	2*10	2*12
500 Pa	7	8	10	11	13	14	16	17	19	21	23	24	2*15	2*17
1000 Pa	9	11	13	15	17	19	20	22	24	26	28	29	2*20	2*22

Required minimum torque per damper motor for opening/closing at varying differential pressure across the damper.

Compact Filter DVG

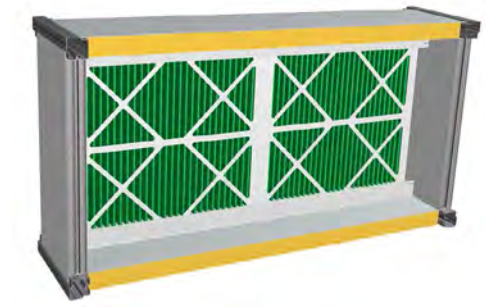

Function

Prefilter.
DVG 10-240.

Filter surface area

Large surface area due to the pleated filter form.

Filter classification

G4 according to EN 779:2012.

Filter frame

Framework encasing the filter with U-profiles.

Filter material

Synthetic polyester fibres.

Accessories

U-tube manometer.

Unit size	Number and size
DV10	2x[376x376x44]
DV15	2x[448x448x44]
DV20	1x[241x495x44] + 1x[495x495x44] + 1x[391x495x44]
DV25	2x[445x622x44] + 1x[391x622x44]
DV30	3x[445x622x44]
DV40	6x[495x368x44]
DV50	6x[622x391x44]
DV60	8x[495x495x44]
DV80	4x[495x495x44] 4x[495x597x44]
DV100	10x[445x622x44]
DV120	15x[495x445x44]
DV150	21x[391x495x44]
DV190	15x[592x592x25] *
DV240	15x[592x592x25] + 8x[287x592x25] *

* Only in combination with DVF with inspection section for filter change on the dirty side.

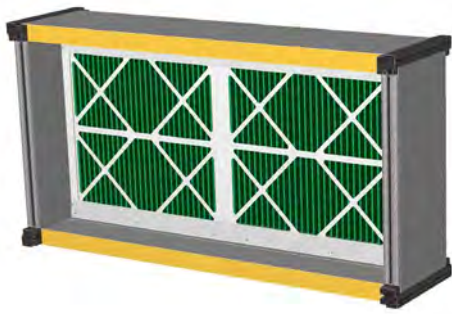

Filter fitted to a single height unit.

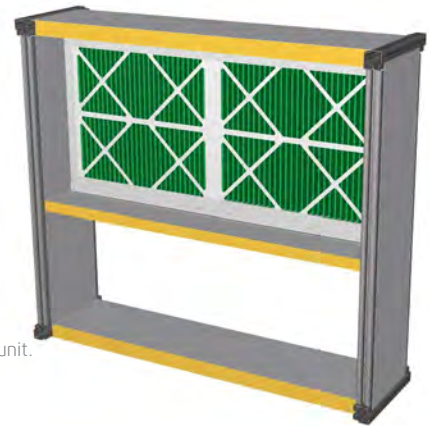

Filter fitted to the upper part of a double height unit.

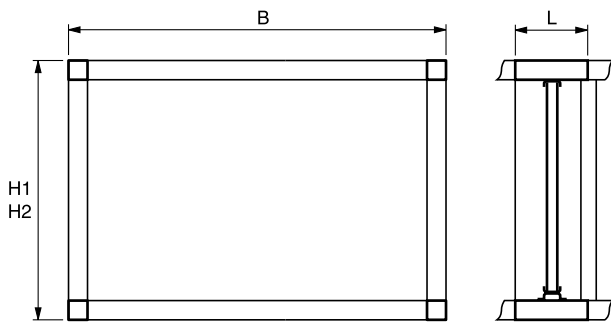

H1: Single height unit
H2: Double height unit

Dimensions

Size	10	15	20	25	30	40	50	60	80	100	120	150
B	970	1120	1270	1420	1570	1720	2020	2170	2170	2370	2590	2890
H1	520	595	670	745	820	895	1045	1120	1270	1420	1570	1720
H2	970	1120	1270	1420	1570	1720	2020	-	-	-	-	-
L	150	150	150	150	150	150	150	150	150	150	150	150

Bag Filter DVF



Function

Pre-filter, medium or fine filter.

Filter classification

G4, M5, M6, F7, F8, F9 and F7 City-Flo according to EN 779:2012.

Filter material

G4: Synthetic material.

M5, M6, F7, F8

F9: Glass fibre material.

F7 City-Flo glass fibre and coal with a wide spectrum.

Filter frame

The filter cells are supplied with 25 mm standard plastic frame.

Therefore, used filters can be disposed of in their entirety by combustion. DVF 40 is supplied only with steel frame.

Sealing

Rubber sealing strips are fixed to the filter cabinet. Air tightness according to EN 1886:2008.

Fitting the filter cells

DVF 10-150: The filter cells are pressed against the sealing strips and locked into place using a sliding rail system. This system is easy to operate by using a large handle.

DVF 190-240: The filter cells are pressed against the sealing strips in the filter bank frames with effective fasteners.

Positioning of an F9 filter

The class F9 filter should always be positioned on the positive pressure side of the supply air unit (EN 1886:2008).

DVF 190-240, pre-filters

DVF can be supplied with pleated formed pre-filters, if the filter section is combined with inspection section for filter change at the dirty side. The filters are placed together with the bag filters into the filter bank frames.

Accessories

- Inspection window
- Pressure tapping
- Light with external switch
- U-tube manometer
- Inclined tube manometer
- Magnehelic manometer
- Stainless steel sheet under the filters
- Spare filter set.

Unit size	Number and size of frames	G4 370 mm number of bags	M5 520 mm number of bags	M6 520 mm number of bags	F7/F8-9 520 mm number of bags	F7L/F8-9L 640 mm number of bags	F7 City-Flo 520 mm number of bags
DV10	1x[792x392]	12	12	12	12	12	12
DV15	2x[490x392]	8	8	8	8	8	8
DV20	1x[490x490] + 1x[592x490]	8+6	8+6	8+10	8+10	8+10	8+10
DV25	2x[592x592]	6	6	10	10	10	10
DV30	1x[592x592] + 1x[490x592] + 1x[287x592]	6+5+3	6+5+3	10+8+5	10+8+5	10+8+5	10+8+5
DV40	3x[490x742] (delivered with steel frame)	5	5	8	8	8	-----
DV50	3x[592x490] + 3x[592x287]	6+6	6+6	10+10	10+10	10+10	10+10
DV60	8x[490x490]	5	5	8	8	8	8
DV80	4x[490x592] + 4x[490x490]	5+8	5+8	8+8	8+8	8+8	8+8
DV100	4x[592x592] + 4x[490x592]	6+5	6+5	10+8	10+8	10+8	10+8
DV120	4x[592x592] + 4x[592x490] + 4x[592x287]	6+6+6	6+6+6	10+10+10	10+10+10	10+10+10	10+10+10
DV150	9x[592x490] + 6x[490x490]	6+8	6+8	10+8	10+8	10+8	10+8
DV190	15x[592x592]	6	6	10	10	10	10
DV240	15x[592x592] + 3x[287x592] + 5x[592x287]	6+3+6	6+3+6	10+5+10	10+5+10	10+5+10	10+5+10

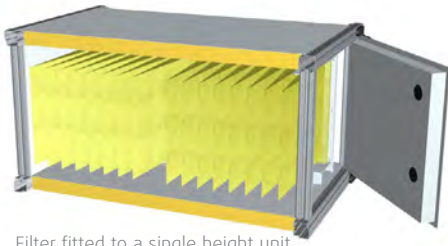

Filter fitted to a single height unit.

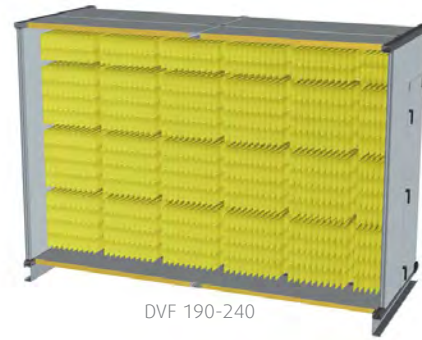

DVF 190-240

DVF 10-240

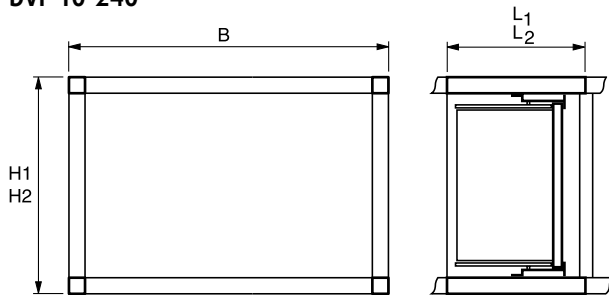

H1: Single height unit
 H2: Double height unit
 L₁: G4, M5, F7, F9
 L₂: F7L, F9L

DVF 190-240

With inspection section for filter change on the dirty side.

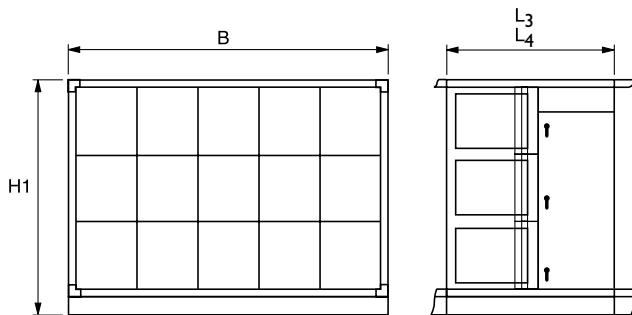

L₃: G4, M5, F7, F9
 L₄: F7L, F9L

Dimensions

Size	10	15	20	25	30	40	50	60	80	100	120	150	190	240
B	970	1120	1270	1420	1570	1720	2020	2170	2170	2370	2590	2890	3190	3490
H1	520	595	670	745	820	895	1045	1120	1270	1420	1570	1720	2170	2470
H2	970	1120	1270	1420	1570	1720	2020	-	-	-	-	-	-	-
L1	600	600	600	600	600	600	600	600	600	600	600	600	600	600
L2	750	750	750	750	750	750	750	750	750	750	750	750	750	750
L3	-	-	-	-	-	-	-	-	-	-	-	-	1200	1200
L4	-	-	-	-	-	-	-	-	-	-	-	-	1350	1350

Rotary Heat Exchanger DVC



Function

Regenerative heat exchanger with high efficiency.

Versions

DVC are available in 4 versions:

- 1,9 mm – low pressure drop
= standard efficiency
- 1,7 mm – normal pressure drop
= normal efficiency
- 1,5 mm – medium high pressure drop
= medium high efficiency
- 1,4 mm – high pressure drop
= high efficiency

Variants

DVC are available in 3 variants: Standard, enthalpy and sorption heat exchanger.

P/PT - Standard heat exchanger.

Winter: This variant is mainly used for recovery of heat from the extract air. However, there may also be recovered moisture from the extract air through condensation at low outdoor temperatures. Summer: Recovery of cooling energy from the extract air. Available in version: 1,9 mm, 1,7 mm, 1,5 mm and 1,4 mm.

E/ET - Enthalpy heat exchanger.

Winter: This variant has a hygroscopic surface so that recovery of heat and moisture is possible before condensation. In this way, high extract air enthalpy content can contribute to the heating and humidification of the supply air. Summer: Recovery of cooling energy from the extract air and lightly dehumidification of outdoor air before cooling. Available in version: 1,9 mm, 1,5 mm and 1,4 mm.

N - Sorption heat exchanger:

This variant has a surface coating of Zeolit, which is a material that has unique properties in terms of absorbing and releasing moisture.

Winter: Recovery of heat and moisture from the extract air. In this way, high extract air enthalpy content can deliver a large contribution to the heating and humidification of the supply air. Summer: Recovery of cooling energy from the extract air and dehumidification of outdoor air before cooling. Large power savings for cooling can be achieved hereby as less energy is required for condensation on the cooling coil. Available in version: 1,7 mm and 1,4 mm.

Rotor

The rotor is made with a hub with bearings and two layers of aluminium. The first layer is smooth and the second is corrugated. The two layers are rolled up to the required outer diameter, and then fixed in a very stable construction. The height of the corrugation determines the pressure drop as well as the mass of the rotor and thus also the efficiency.

Aluminium foil D is 0,07 mm and used for standard and enthalpy exchangers, which are delivered assembled. Aluminium foil C is 0,08 mm and used for sorption exchangers and exchangers which are delivered divided. Foil width is 200 mm.

Sealing

In order to safeguard against leakage between the airflows the heat

exchanger is fitted with highly effective brush type seals against the rotor.

Service-friendly

The heat exchanger is equipped with a large inspection door. The exchangers in sizes DVC 10 to 40 are assembled on guide rails enabling the rotor to be removed for inspection.

Division of large heat exchangers

On account of transport the exchangers from size 60 can be supplied divided in the height. The sizes 190 and 240 are always supplied divided. The lower half of the exchanger and the hub of the rotor are assembled into the lower half of the AHU casing. All other parts of the heat exchanger are supplied for local assembling.

Purging sector

The exchanger is available with a purging sector that minimises the transfer of extract air to supply air. This function is dependent on a higher pressure on the supply air side than on the extract air side, both before and after the exchanger.

Drive system

An electronic control unit and a slow rotating motor drive the exchanger. This provides an accurate and stepless regulation of the rotor speed. In this way the exchanger efficiency is controlled. The drive system can also be set up for constant speed. In this way the exchanger provides full heat recovery when it is in operation.

Direction variants

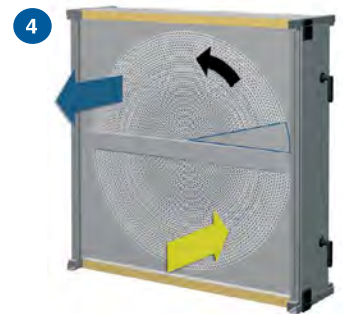
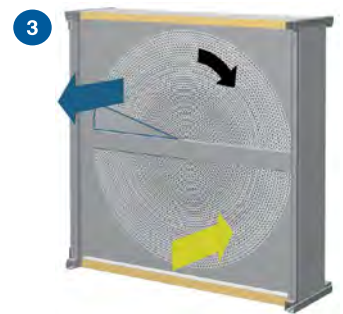
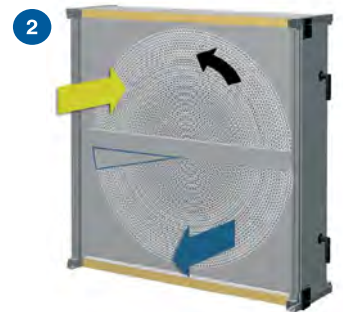

Supply air Extract air

Function

The heat exchanger has a built-in electronic control unit and a slow rotating motor. This makes up a complete drive system for stepless regulation of the heat exchanger speed. The control system is delivered with fully assembled cable connections between the control unit and motor.

Mains connection

1 x 230 V, 50/60 Hz.

Operation indication

The control unit has a LED that indicates the actual operating situation.

Control signal

The control unit can be regulated by an external 0-10 VDC control signal. For standard and enthalpy heat exchangers 0-10 V corresponds to 0-10 rpm, and for sorption heat exchangers to 0-20 rpm.

Alarm connections

Built-in relay for connection to an alarm system. By an undesirable operating situation an alarm is tripped.

Protection

Built-in protection against unstable voltage supplies from the mains. Built-in overcurrent protection, which protects the motor against overloading.

Rotary alarm switch

Built-in system for monitoring the rotor operation position. Gives a signal by way of an alarm connection, if the rotor operation is interrupted unintentionally.

Purging

Outside of the normal operating period the rotor is turned slowly 12 sec. every 15 min. in order to purge the rotor with clean air.

Cooling recovery

The heat exchanger can be activated for the recovery of cooling energy via the external control signal.

Data for rotor drive system, standard and enthalpy heat exchangers

System		Motor		Control unit			
DVC size	Type	Torque, Nm	Power, W	Type	Voltage, V	Current, A	Max. fuse
10-40	90 TYD-M	2,8	85	RHC 200	1 x 230	0,4	10 A
50-150	120 TYD-M	5,5	145	RHC 200	1 x 230	0,6	10 A
190-240	120 TYD-L	7,5	370	RHC 200	1 x 230	1,6	10 A

Data for rotor drive system, sorption heat exchanger

System		Motor		Control unit			
DVC size	Type	Torque, Nm	Power, W	Type	Voltage, V	Current, A	Max. fuse
10	90 TYD-M	2,8	85	RHC 200	1 x 230	0,4	10 A
15-60	120 TYD-M	5,5	145	RHC 200	1 x 230	0,6	10 A
80-240	120 TYD-L	7,5	370	RHC 200	1 x 230	1,6	10 A

Mains electrical connection must not be cut-off outside the normal operating period, as this will terminate the purging function.

Rotary Heat Exchanger DVC

DVC 10-50

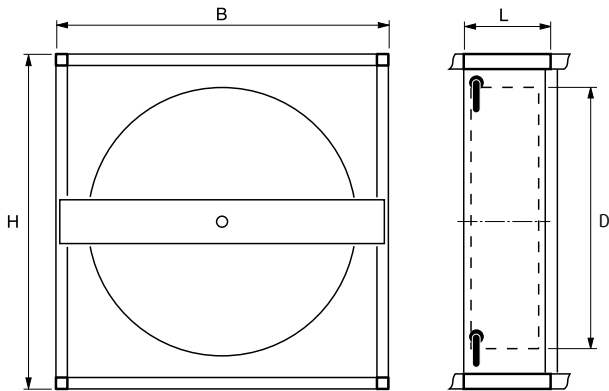

DVC 60-150

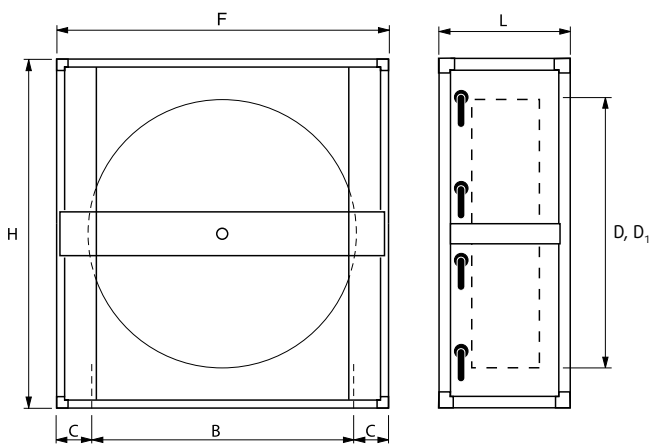

DVC 190-240

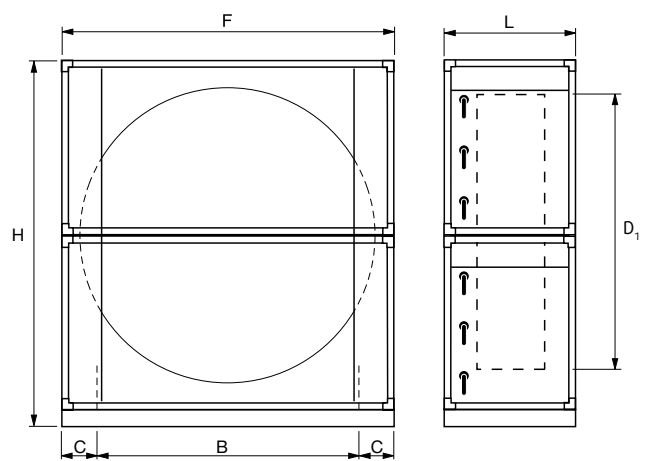

D₁: Divided version.

Dimensions

Size	10	15	20	25	30	40	50	60	80	100	120	150	190	240
B	970	1120	1270	1420	1570	1720	2020	2170	2170	2370	2590	2890	3190	3490
H	970	1120	1270	1420	1570	1720	2020	2240	2540	2840	3140	3440	4340	4940
L	300	300	300	300	300	300	450	520	520	520	520	520	670	670
F	-	-	-	-	-	-	-	2170	2320	2520	2890	3040	3720	4020
C	-	-	-	-	-	-	-	0	75	75	150	75	265	265
D	820	970	1120	1270	1420	1570	1780	1900	2100	2300	2600	2770	-	-
D1	-	-	-	-	-	-	-	1880	2045	2270	2600	2720	3300	3600

DVC 60-240

Heat exchanger supplied in divided version.

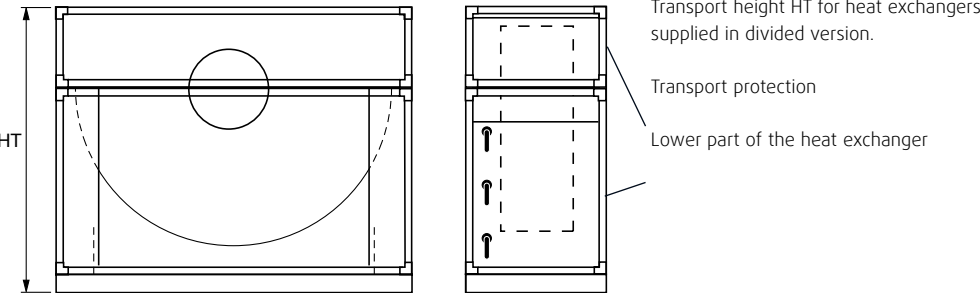

Transport height HT

Size	60	80	100	120	150	190	240
HT	1640	1790	1940	2090	2240	2765	3065

Plate Heat Exchanger DVQ



Function

Recuperative plate heat exchanger with high efficiency.

Application

The plate heat exchanger is used where there are special requirements for separation of the two airflows, e.g. in order to avoid transfer of odours to the supply air.

Versions

S – Standard cross flow heat exchanger
DVQ 10-150
Efficiency up to 65%

H – High efficiency cross flow heat exchanger
DVQ 10-150
Efficiency up to 75%

C – Counter flow heat exchanger
DVQ 10-50
Efficiency up to 90%

Variants

The versions are available in 2 variants:

- A – Aluminium heat exchanger
Version S, H and C is used in ventilation plants where the air does not contain corrosive elements, e.g. ventilation plants for commercial purposes. Many chemicals and solvents do not attack aluminium. This heat exchanger can be used where the air contains these substances. The conditions should be evaluated for each plant.
- K – Corrosion resistant heat exchanger. Version S and H. The heat exchanger plates are coated with corrosion resistant synthetic material. Can be used in plants where the air contains elements which attack aluminium.

By-pass

The heat exchanger is supplied with a built-in by-pass that can regulate the heat recovery from 0-100%. The by-pass function is comprised of a damper for the heat exchanger and a damper for the by-pass airway. The

by-pass function is located in the middle of DVQ-S 100-150, DVQ-H 100-150 and DVQ-C 10-50. Consequently, the heat exchanger is divided.

Service-friendly

The heat exchanger is equipped with large inspection doors that give access for inspection and service. As the heat exchanger has no rotating part, it requires very little service.

De-icing

In situations where the outdoor air is extremely cold there is a risk of the exchanger icing up. De-icing can take place either by regulating the by-pass damper or by reducing the supply air flow.

Drip tray

A drip tray is fitted beneath the heat exchanger for collection of the water that can condense in the extract air. The drip tray drain outlet must be fitted with a water trap that is designed for the actual pressure difference. Refer to the assembly instructions. The counter flow heat exchanger is fitted with a drip tray in both extract and supply air sections.

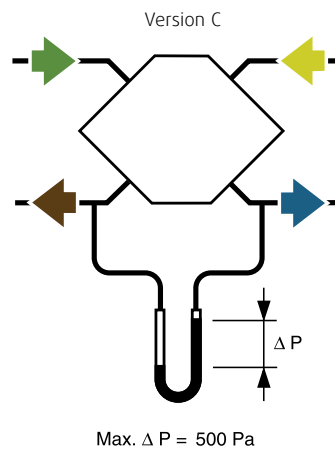
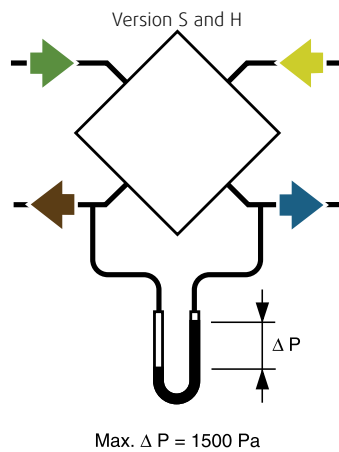

Air direction variants
Extract air, diagonal **down-flow**
DVQ-S, -H and -C

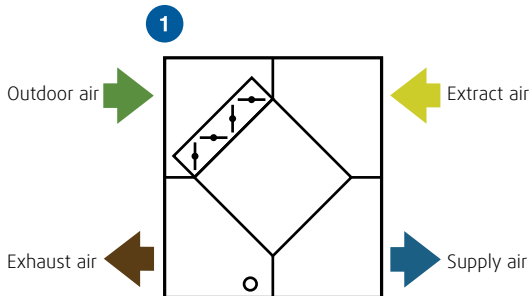

Air direction variants
Extract air, diagonal **up-flow** *
DVQ-S and -H

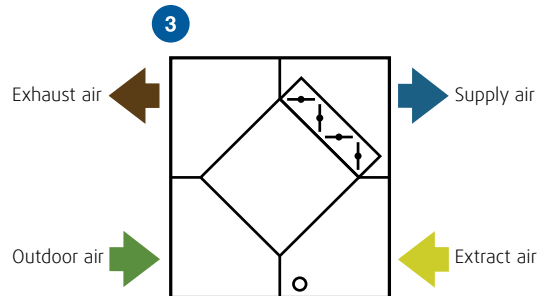

2 DVQ-S and -H

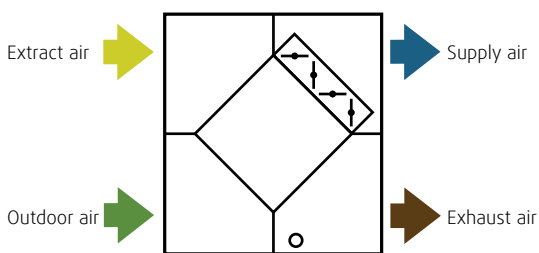

4 DVQ-S and -H

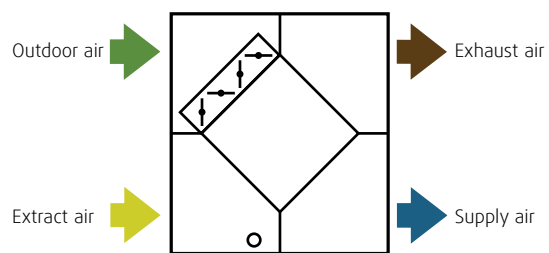

* Air directions with up-flow extract air (3 and 4) should only be used when the moisture content of the extract air, before the heat exchanger, is less than the following values:

Supply air before heat exchanger °C	0	-10	-20	-30
Extract air before heat exchanger max. g moisture/kg air	10	8	6	4

Plate Heat Exchanger DVQ

DVQ-S 10-50

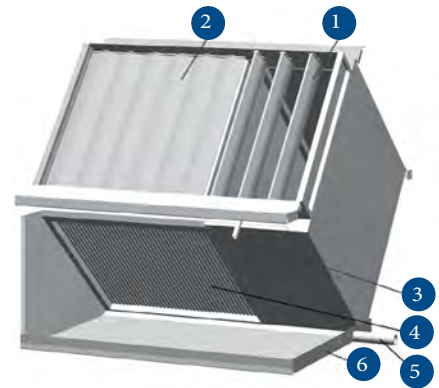
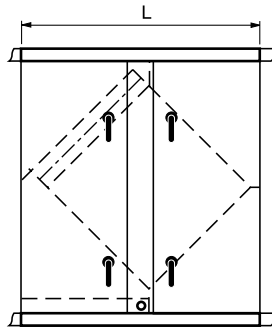
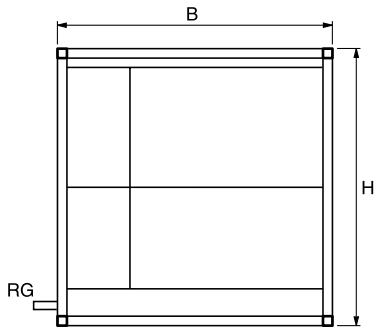

DVQ-H 10-50

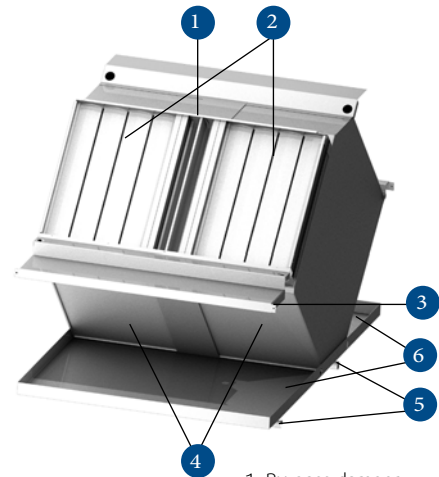
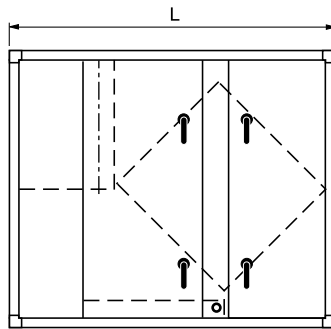
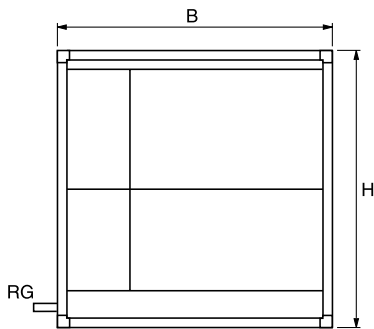

DVQ-C 10-50

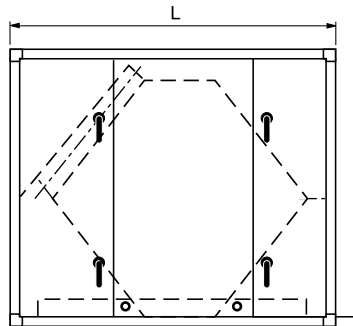
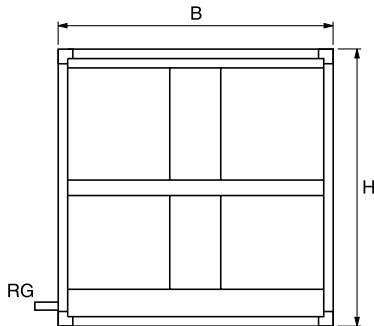

DVQ-H 60

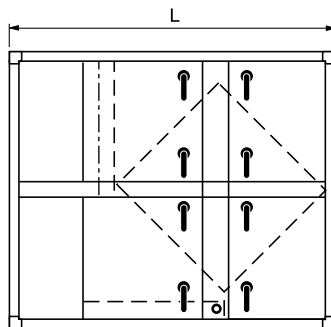
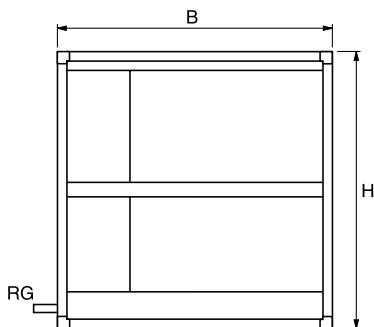

1. By-pass damper
2. Heat exchanger damper
3. Shaft for damper motor
4. Plate heat exchanger
5. Drip tray drain outlet
6. Drip tray

DVQ-S 60-80, DVQ-H 80

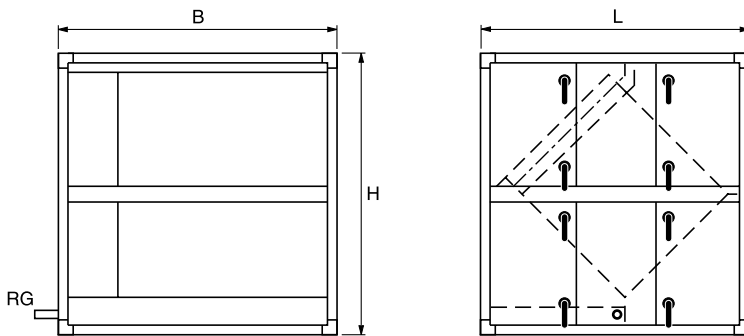

DVQ-S 100-150, DVQ-H 100-150

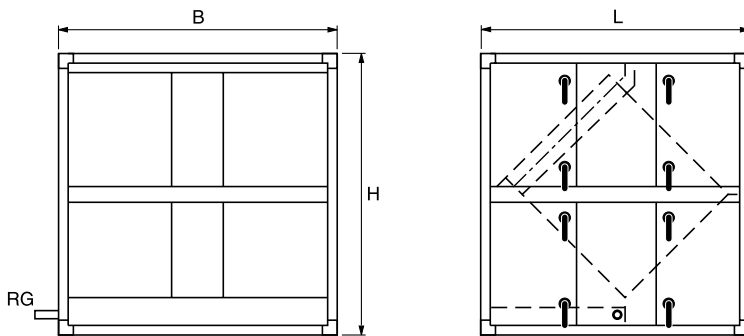

Dimensions

Size	10	15	20	25	30	40	50	60	80	100	120	150
B	970	1120	1270	1420	1570	1720	2020	2170	2170	2370	2590	2890
H	970	1120	1270	1420	1570	1720	2020	2240	2540	2840	3140	3440
L vers. S	1050	1200	1200	1500	1500	1650	1650	2020	2020	2320	2620	3070
L vers. H	1420	1720	1820	2170	2320	2320	2840	3290	2470	2470	3220	3220
L vers. C	1420	1570	1720	1720	2020	2020	2170					
RG-S/H	1"	1"	1"	1"	1"	1½"	1½"	1½"	1½"	1½"	1½"	1½"
RG-C	2 x 1"	2 x 1"	2 x 1"	2 x 1"	2 x 1"	2 x 1"	2 x 1"					

Torque (Nm) for each damper

Size	10	15	20	25	30	40	50	60	80	100	120	150
Number	1	1	1	1	1	1	1	1	1	3	3	3
Nm	8	10	12	14	16	18	20	22	24	20	120	20

Required torque for the damper motor. Shaft for damper motor: □14,3 mm.

Run-around Coil Heat Exchangers DVR

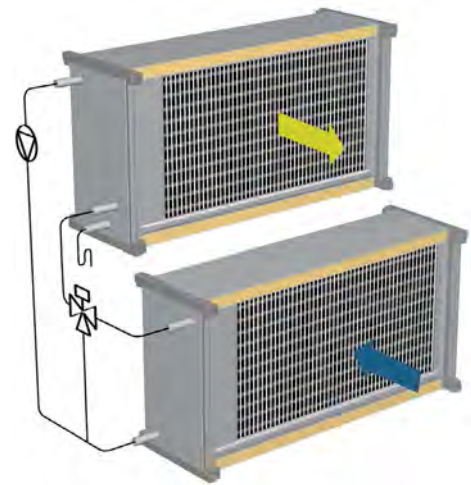

Function

Heat exchanger system with a heating coil built into the supply air side and a cooling coil built into the extract air side. The coils must be connected with a piped circuit in which a water/glycol mixture is circulated.

Application

The run-around coil heat exchangers are used where it is a requirement that the two airflows must be kept completely separated, or where they are at a distance from each other, e.g. on two storeys of a building.

Variants

- Standard – Coil completely built into the unit.
- MAX – Coil which is wider than the unit. DVR 10-150.

Construction

The heat exchanger coils consists of copper tubes with aluminium fins.

Tubes

- Z – Copper tubes $\varnothing 10$ mm. Used for lower capacity heat exchangers.
- Y – Copper tubes $\varnothing 15$ mm. Used for higher capacity heat exchangers.

Fins

- Al – Standard aluminium.
- Alup – Aluminium with a synthetic coating. Used for mildly corrosive air.
- AlMg₃ – Aluminium-magnesium alloy. Used for air in connection with seawater.

Drip tray

The extract air section is fitted with a drip tray for collection of condensed water. The drip tray drain outlet must be fitted with a water trap that is designed for the actual pressure difference. Refer to the assembly instructions.

Droplet eliminator

DVR is available with a droplet eliminator in the extract air section.

Regulation

A motorised valve built into the pipe circuit regulates the heat exchanger capacity.

Piped circuit example

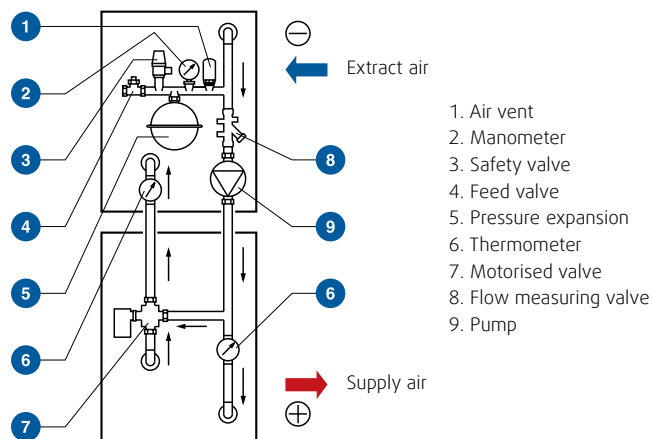

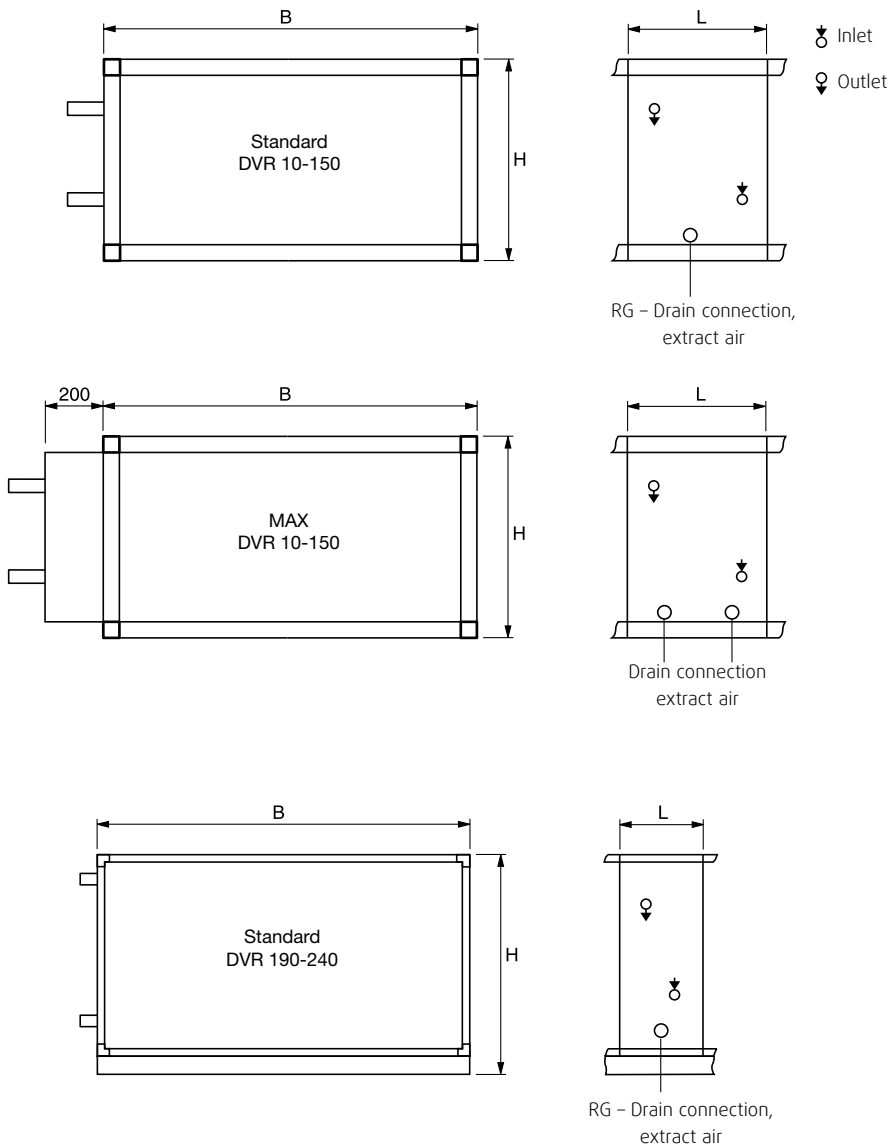

Dimensions

Size	10	15	20	25	30	40	50	60	80	100	120	150	190	240
B	970	1120	1270	1420	1570	1720	2020	2170	2170	2370	2590	2890	3190	3490
H	520	595	670	745	820	895	1045	1120	1270	1420	1570	1720	2170	2470
	300	300	300	300	300	300	300	300	300	300	300	300	300	300
Supply air L*	450	450	450	450	450	450	450	450	450	450	450	450	450	450
	600	600	600	600	600	600	600	600	600	600	600	600	600	600
	450	450	450	450	450	450	450	450	450	450	450	450	600	600
Extract air L*	600	600	600	600	600	600	600	600	600	600	600	600	750	750
	750	750	750	750	750	750	750	750	750	750	750	750	900	900
RG	1"	1"	1"	1"	1"	1½"	1½"	1½"	1½"	1½"	1½"	1½"	1½"	1½"

* L is dependent on the capacity.

Heating Coil DVH



Function

Air heater

Heating media

W – Hot water.

Max. temperature 100 °C,
max. working pressure 10 Bar.
Available for temperatures up to
130 °C.

C – Condensation of refrigerant.

Max. working pressure depending
on the type of refrigerant.

E – Electrical heating.

Variants

Standard – Heating coil completely
built into the unit.

MAX – Heating coil which is
wider than the unit.
Hot water and conden-
sation coils only.
DVH 10-150.

Construction

Finned coils for hot water and con-
densation consist of copper tubes
with aluminium fins. Coils for electri-
cal heating consist of stainless steel
tube heating elements.

Copper tubes

Z – Copper tubes \varnothing 10 mm. Used for
lower capacity heating coils.

Y – Copper tubes \varnothing 15 mm. Used for
higher capacity heating coils.

Fins

Al – Standard aluminium.

Alup – Aluminium with a synthetic
coating. Used for mildly
corrosive air.

AlMg₃ – Aluminium-magnesium
alloy. Used for air in
connection with seawater.

Frost protection

Heating coils for hot water are availa-
ble with a connection piece for the
fitting of a temperature sensor in the
water circuit.

Electrical heating

The inspection door, which can be
opened only by using a key, gives
access to a terminal box for the elec-
trical connections. The coil has a
built-in safety thermostat with an
automatic reset function and an over-
heating thermostat with manually
resetting.



Electrical heating coil



Hot water heating coil

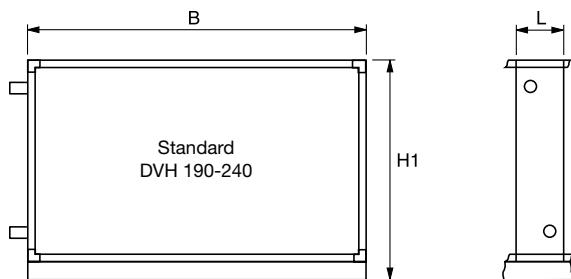
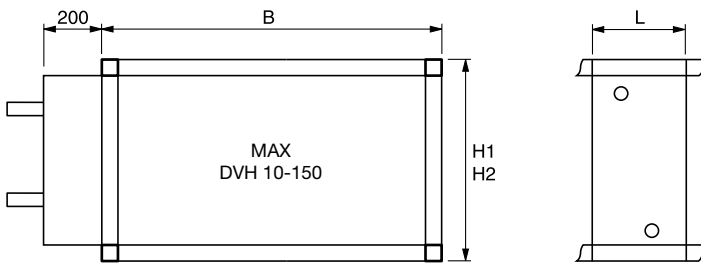
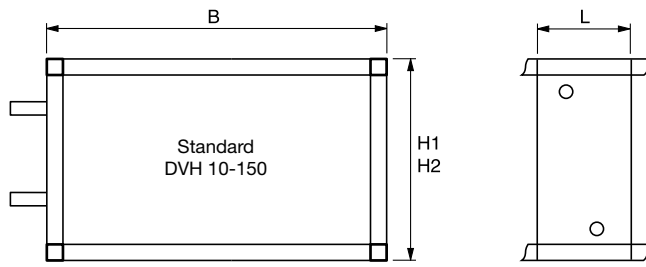

Pipe connections

♂ Inlet

♀ Outlet

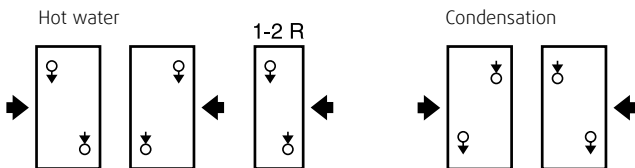

Dimensions

Size	10	15	20	25	30	40	50	60	80	100	120	150	190	240
B	970	1120	1270	1420	1570	1720	2020	2170	2170	2370	2590	2890	3190	3490
H1	520	595	670	745	820	895	1045	1120	1270	1420	1570	1720	2170	2470
H2	970	1120	1270	1420	1570	1720	2020	-	-	-	-	-	-	-
L*	150	150	150	150	150	150	150	150	150	-	-	-	-	-
-	300	300	300	300	300	300	300	300	300	300	300	300	300	300
-	450	450	450	450	450	450	450	450	450	450	450	450	450	450
-	600	600	600	600	600	600	600	600	600	600	600	600	600	600

H1: Single height unit, H2: Double height unit.

* Heating coils for hot water (W), condensation (C) or electrical heating (E).

Cooling Coil DVK



Function

Air cooler.

Cooling media

W – Cold water.

Max. working pressure 10 Bar.

D – Evaporation.

Max. working pressure depending on the type of refrigerant.

Variants

Standard – Cooling coil completely built into the unit.

MAX – Cooling coil which is wider than the unit. DVK 10-150.

Construction

Finned coils consist of copper tubes with aluminium fins.

Copper tubes

Z – Copper tubes \varnothing 10 mm.
Used for lower capacity cooling coils.

Y – Copper tubes \varnothing 15 mm.
Used for higher capacity cooling coils.

Fins

Al – Standard aluminium.

Alup – Aluminium with a synthetic coating. Used for mildly corrosive air.

AlMg₃ – Aluminium-magnesium alloy. Used for air in connection with seawater.

Pipe connections

The connection pipes for the cooling coil are placed outside of the air handling unit. The cooling coil for evaporation has the liquid distributor placed inside the unit section. The expansion valve can be fitted to the connection piece outside of the unit.

Drip tray

The cooling coil section is fitted with a drip tray for collection of condensed water. The drip tray drain outlet must be fitted with a water trap that is designed for the actual pressure difference. Refer to the assembly instructions.

Droplet eliminator

DVK is available with a droplet eliminator that prevents condensed water droplets from being carried into the airflow.



Cooling coil fitted into a single height unit.



Cooling coil fitted into a double height unit.

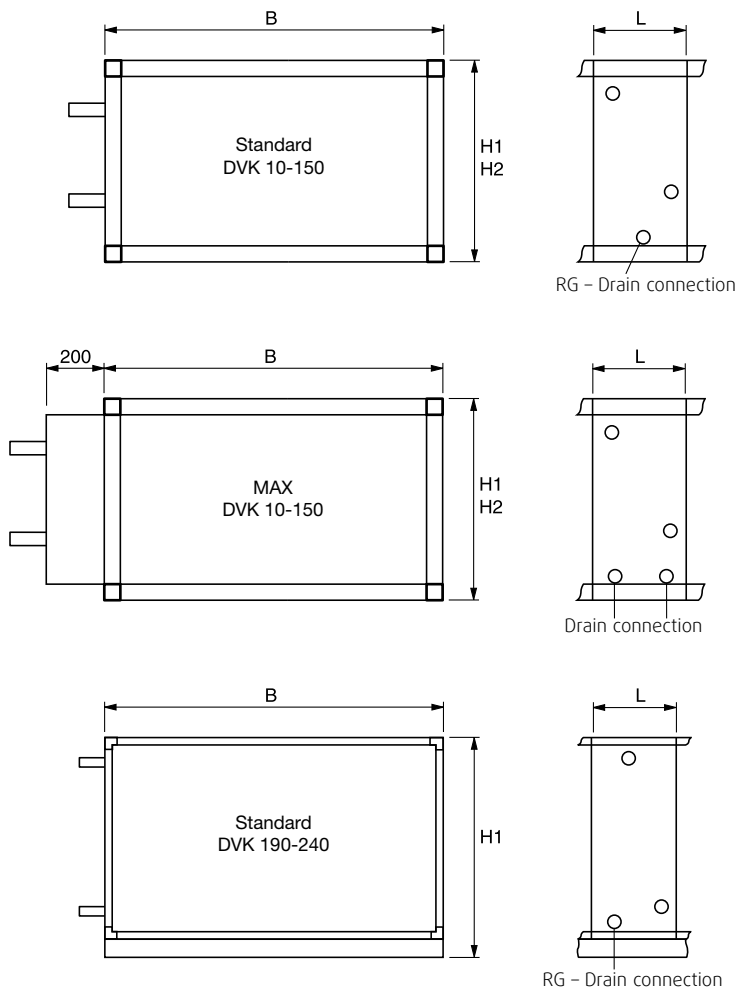

Pipe connections

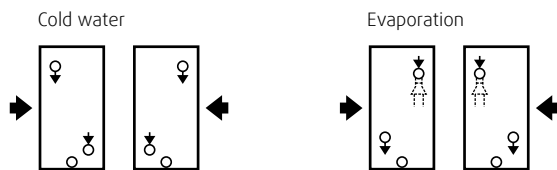

Dimensions

Size	10	15	20	25	30	40	50	60	80	100	120	150	190	240
B	970	1120	1270	1420	1570	1720	2020	2170	2170	2370	2590	2890	3190	3490
H1	520	595	670	745	820	895	1045	1120	1270	1420	1570	1720	2170	2470
H2	970	1120	1270	1420	1570	1720	2020	-	-	-	-	-	-	-
L*	450	450	450	450	450	450	450	450	450	450	450	450	600	600
-	600	600	600	600	600	600	600	600	600	600	600	600	750	750
-	750	750	750	750	750	750	750	750	750	750	750	750	900	900
RG	1"	1"	1"	1"	1"	1½"	1½"	1½"	1½"	1½"	1½"	1½"	1½"	1½"

H1: Single height unit, H2: Double height unit.

* L is dependent on the capacity.

Change-over Coil DVHK



Function

Heating of air with hot water/glycol.
Cooling of air with cold water/glycol.

Heating/cooling media

W – Hot/cold water.
Max. working pressure 10 Bar.

Variants

Standard – Cooling coil completely built into the unit.

Construction

Finned coils consist of copper tubes with aluminium fins.

Copper tubes

Y – Copper tubes ø15 mm.

Fins

- Al – Standard aluminium.
- Alup – Aluminium with a synthetic coating. Used for mildly corrosive air.
- AlMg₃ – Aluminium-magnesium alloy. Used for air in connection with seawater.

Pipe connections

The connection pipes for the cooling coil are placed outside of the air handling unit.

Drip tray

The cooling coil section is fitted with a drip tray for collection of condensed

water. The drip tray drain outlet must be fitted with a water trap that is designed for the actual pressure difference. Refer to the assembly instructions.

Droplet eliminator

DVHK is available with a droplet eliminator that prevents condensed water droplets from being carried into the airflow.

Frost protection

The cooling coil is available with a connection piece for the fitting of a temperature sensor in the water circuit.



Fitted into a single height unit.



Fitted into a double height unit.

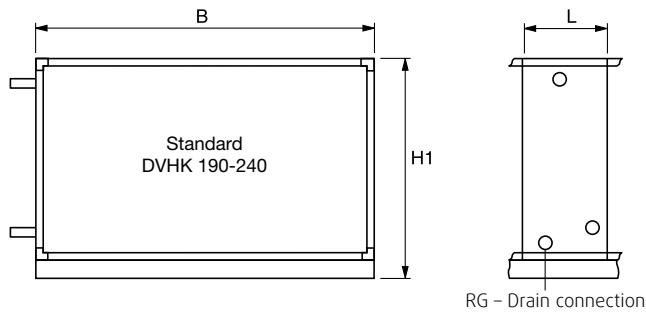
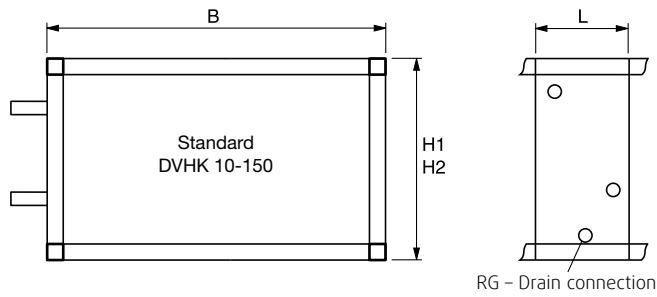

Pipe connections

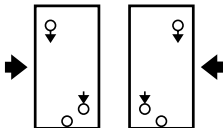

Dimensions

Size	10	15	20	25	30	40	50	60	80	100	120	150	190	240
B	970	1120	1270	1420	1570	1720	2020	2170	2170	2370	2590	2890	3190	3490
H1	520	595	670	745	820	895	1045	1120	1270	1420	1570	1720	2170	2470
H2	970	1120	1270	1420	1570	1720	2020	-	-	-	-	-	-	-
L	450	450	450	450	450	450	450	450	450	450	450	450	600	600
RG	1"	1"	1"	1"	1"	1½"	1½"	1½"	1½"	1½"	1½"	1½"	1½"	1½"

H1: Single height unit, H2: Double height unit.

Integrated Reversible Heat Pump DVU-HP

Function

The DVU-HP is an integrated heat pump system built into a unit section. The system consists of a reversible heat pump and a rotary heat exchanger that enables both heating and cooling. The DVU-HP can be supplied for Danvent DV 10 to 80.

Ready for operation at delivery

DVU-HP is supplied as a complete unit that is ready for operation immediately after installation, as it is configured and tested from the factory. The installation is very simple, as the DVU-HP is placed between the unit sections and connected to power supply and control signals as well as condensate drain. DVU-HP is equipped with complete control system, which controls the safety functions and capacity regulation. The control system can communicate both with Systemair Corrigo control system and other control solutions.

Construction

DVU-HP consists of a heat pump system with a 4-way reversing valve

so that the system can heat or cool the supply air. Additionally, a rotary heat exchanger is built-in for efficient heat recovery. The combination of heat pump and rotary heat exchanger ensures excellent operating economy in both heating and cooling situations. DVU-HP is equipped with two scroll compressors (1 compressor for DV 10 and DV 15). The capacity is controlled through the modulating digital function on one of the scroll compressors.

Capacity control

The capacity of the DVU-HP can be controlled between 5-100% via a 0-10 V DC signal from the air handling unit's control system. In addition, the control system controls the cooling recovery with the rotary heat exchanger when cooling is required. The outdoor air is cooled by the rotary heat exchanger when the temperature of the extract air is lower than the temperature of the outdoor air. In cooling mode, heat is discharged from the compressor system via the condenser in the exhaust air after the rotary heat exchanger.

Refrigerant

Type R-410A

Electrical connection

3 x 400 V + N + PE
Start/stop signal
Heating/cooling mode signal
0-10 V DC for capacity control
Alarm signal.

Service-friendly

DVU-HP has a very service-friendly design with easy access to all components inside the large inspection doors.

Condensation tray

The drain outlet must be connected to a water trap with sufficient locking height.

SystemairCAD, design programme

The programme is very user-friendly and it is easy and simple to select DVU-HP. When the unit design is finished, SystemairCAD makes all technical calculations and a complete documentation. This ensures a quick overview of capacities, energy consumption, detailed consulting text and dimension drawings, in a detailed pdf-printout.

Dimensions

DVU-HP size	Width	Height	Length
DVU-HP 10	970	970	1420
DVU-HP 15	1120	1120	1420
DVU-HP 20	1270	1270	1420
DVU-HP 25	1420	1420	1420
DVU-HP 30	1570	1570	1570
DVU-HP 40	1720	1720	1570
DVU-HP 50	2020	2020	2320
DVU-HP 60	2170	2240	2460
DVU-HP 80	2170/2320*	2540	2460

* Rotary heat exchanger.

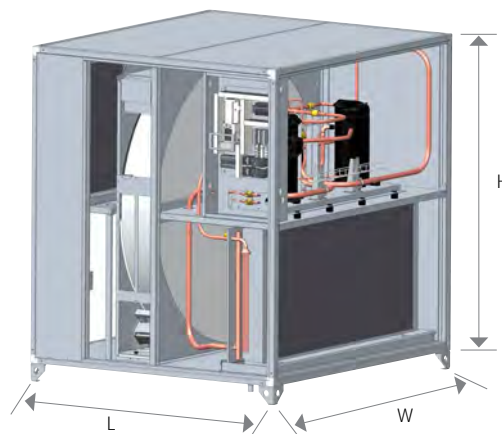

Cooling and heating capacity, example with DV 40 med DVU-HP

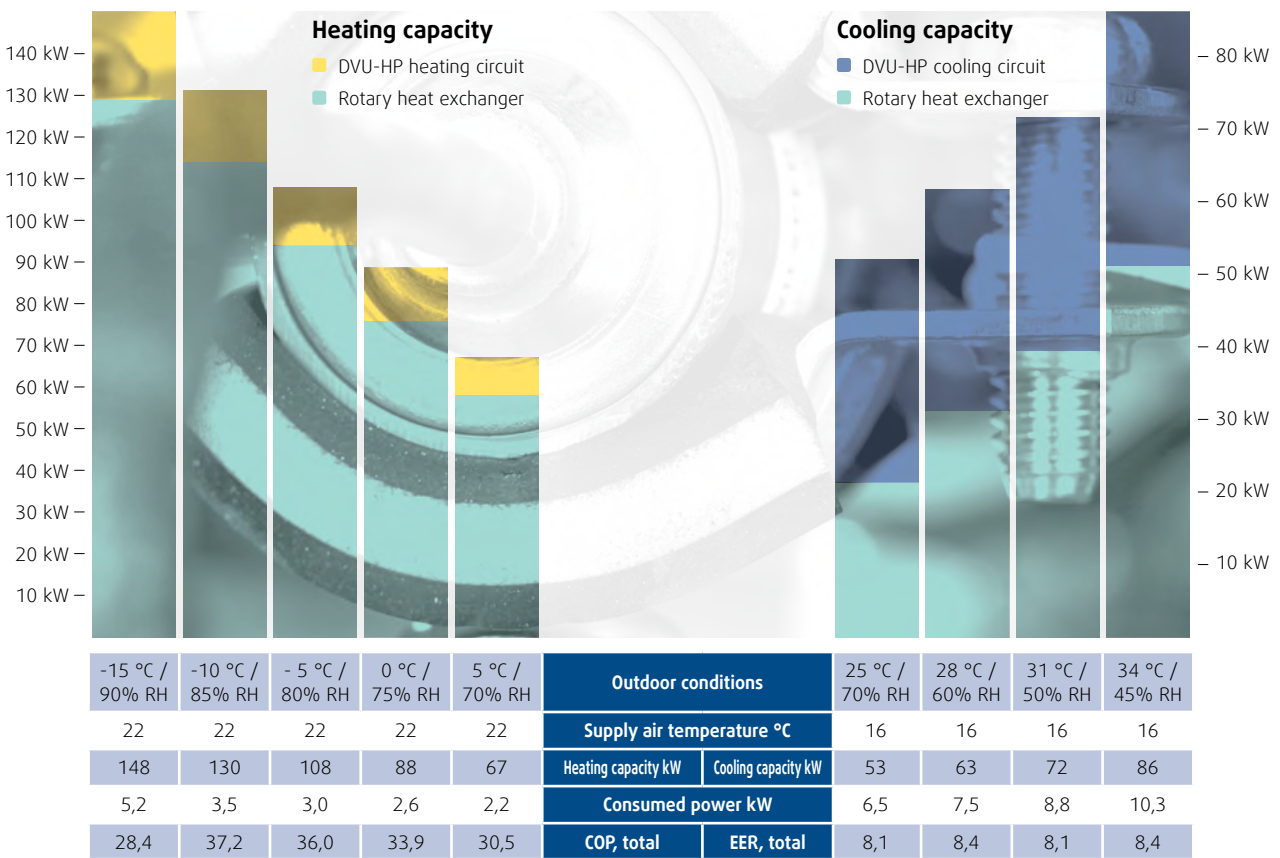

Performance example: DV 40 with 2,5 m³/s. Extract 22 °C/35% RH. Defrosting is not taken into account.

Performance example: DV 40 with 2,5 m³/s. Extract 23 °C/63% RH.

Cooling capacity

Unit size	DV 10	DV 15	DV 20	DV 25	DV 30	DV 40	DV 50	DV 60	DV 80
Recommended max. airflow m ³ /s	0,8	1,2	1,6	2,0	2,5	3,0	4,0	4,8	5,3
Total cooling capacity kW	27	41	55	65	79	102	137	165	181
Capacity from the cooling circuit kW	12	18	24	29	34	44	59	73	77
EER, total	7,2	7,1	6,7	6,9	7,1	7,6	8,0	7,5	8,2

Outdoor conditions: 34 °C/45% RH. Supply air: 16 °C. Extract air conditions: 23 °C/63% RH.

Air Humidifier DVX

Function

The function is based on the natural process that water evaporates when air passes a wet surface. By uptake of water vapor in the air, the temperature will decrease due to the fact that heat for the evaporation comes from the air. This is an adiabatic cooling, which means that the enthalpy content of the air is unchanged during the process. This ensures that humidification occurs without releasing drops, unless this is effected by entrainment. Entrainment may be avoided by passing the humidification elements with a suitable low speed or by mounting droplet eliminators, which can handle this.

Application

The humidifier can be placed in the supply air after a heating coil which can preheat the air before humidification. There may also be a need for an after heating coil in order to achieve the desired supply air temperature. In areas with high outdoor temperature and low humidity, placement of the humidifier in the supply air can be used as adiabatic cooling with great advantage. Indirect adiabatic cooling can be achieved by placing in the

extract air before a plate heat exchanger or a standard rotary heat exchanger.

Construction

The humidifier is designed as a complete unit that fits the internal dimensions of a section of length 970 mm in the DV 10 to DV 240. The unit comprises humidification elements, tray and frame made of stainless steel AISI 304, circulation pump, balancing valves for irrigation, overflow, valve for adjusting bleed off, float valve for controlling the water supply to the tray and valve for emptying the tray. Droplet eliminator is included if necessary and sensor for protection of pump at low water level. The drain is led out of the section, and can be selected either on the inspection side or the backside. The drain must be connected to a water trap with sufficient locking height.

Humidification elements

HU-CELL humidification elements are stainless steel frames which contains corrugated fiberglass plates arranged in cross-channel configuration. The corrugated cross-channel configuration ensures that the air is in contact

with a large surface area for evaporation, and at the same time provides a low pressure drop. The glass fiber material is impregnated with a stabilizing and absorbent additive which makes it possible to absorb water without loss of stability. The element is of inorganic material, and is therefore not a feed source for bacteria and mould. The material contains silver ions, which acts as a growth inhibitor. This increases the resistance to the growth of microorganisms and helps to release deposits from the water on the material, so that this remains clean. Silver ions are encapsulated in a chemical mixture, which ensures that their particles do not dissolve to either water or air. The elements are supplied in the following thicknesses 75 mm, 100 mm, 125 mm and 150 mm. This makes it possible to optimize the pressure drop depending on the desired humidification/cooling requirement.

Technical data

The design programme SystemairCAD calculates all important data such as temperature, relative and absolute humidity after the humidifier, pressure drop and water consumption etc.

Operating principles

HEF2E (Recirculated water, standard on/off)

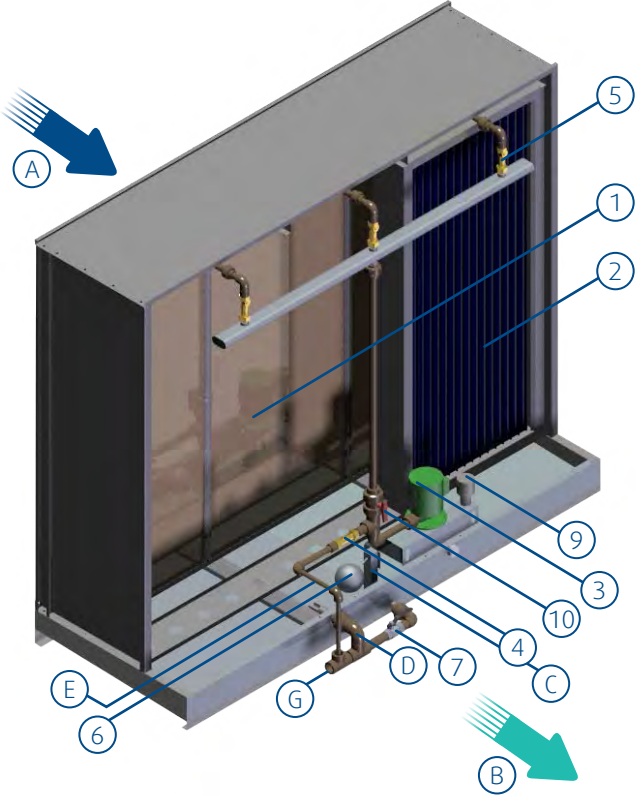
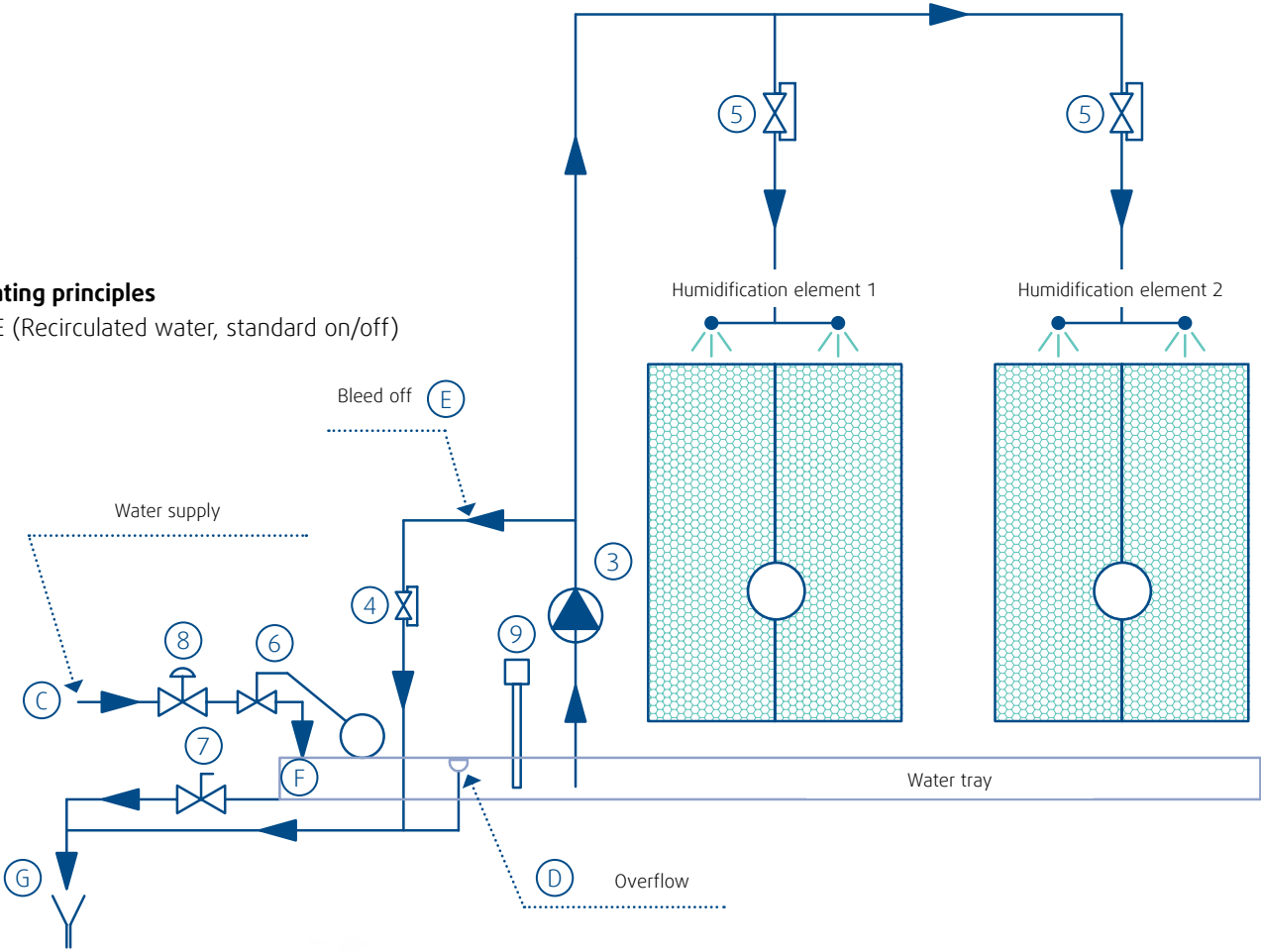

- A Process air
- B Humidified air
- C Water supply
- D Overflow
- E Constant bleed off
- F Draining
- G Water outlet to drain
- 1. Humidification element
- 2. Droplet eliminator (optional)
- 3. Water recirculations pump
- 4. Bleed off regulation valve
- 5. Irrigation regulation valves
- 6. Float valve
- 7. Draining valve
- 8. Filling solenoid valve (optional)
- 9. Max/min water level detector
- 10. Cut-off valve (depending on model)

Plug Fan DVE

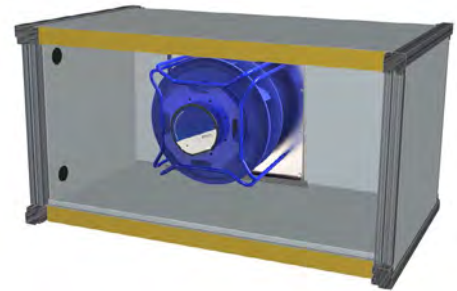

Function

Plug fan built into an acoustically insulated air handling unit.

Construction

Single inlet plug fan with open outlet into the air handling unit. The fan impeller is fitted directly to the motor. The backward curved impeller has low sound power levels in the lower frequencies. Static efficiency up to 75%. For optimizing the plug fan efficiency in the operating point, the fans can be selected in several variations in each unit size:

- S: Low airflow
- M: Medium airflow
- L: High airflow

Variants

DVE comes in two variants:

• DVE-EC Blue

Compact plug fan with an effective composite impeller, and EC external rotor motor with integrated variable speed control. The EC motor is in efficiency class IE4.

• DVE-PM/AC

Plug fan with an effective impeller fitted to the motor shaft. Depending on size the impeller is made of composite material or painted steel. The fan can be supplied with 2 types of motors:

- Highly efficient PM synchronous motor, efficiency class IE4.
- AC asynchronous motor, efficiency class IE2.

PM and AC motors are stepless controllable via frequency converter.

Plug fan

DVE-EC Blue is a compact plug fan with an impeller made of composite material, where all details are optimized in order to achieve a high efficiency. The impeller is fitted directly to an EC external rotor motor with integrated variable speed control. An EC motor is characterized by a high efficiency and excellent control features. For optimizing the efficiency in the operating points, the fan can be selected in several variations in each unit size. Several fans can be positioned in parallel operation at larger units. The fans are mounted on the end wall of the fan section.

DVE-PM/AC is a plug fan with an efficient impeller fitted to the motor shaft. Depending on size, the impeller is made of composite material where all details are optimized, or painted steel. For optimizing the efficiency in the operating points, the fan can be selected in 3 variations in each unit size. 2 fans can be positioned in parallel operation at larger units. The fans are mounted on vibration isolators on the bottom of the fan section. The DVE-PM/AC fan can be supplied with 2 types of motors for 3 x 400 V AC:

- PM – Permanent magnet – synchronous motor. The motor has a very high efficiency, since the rotor is made of magnetic material, which eliminates the slip, so that heat generation and losses in the motor are reduced. Efficiency class IE4 according to EN 60034-31. The motor is stepless controllable

through a frequency converter, which is adapted exactly to the individual motor and fan. Parallel operation of Twin fans is controlled by two frequency converters with the same control signal.

- AC – Induction – asynchronous motor. Efficiency class IE2 according to EN 60034-30:2009. The motor is stepless controllable through a frequency converter. Parallel operation of Twin fans is controlled by one frequency converter.

Positioning in the air handling unit

A plug fan supplies air at the fan section outlet with a low and even air speed. Therefore, it is an advantage to position air handling components on the outlet side of the fan.

Service-friendly

DVE has a large inspection door giving easy access for service. DVE-PM/AC in sizes 10-30 has the fan and motor assembled on guide rails which allows easy extraction from the unit.

Sound data

The design programme SystemairCAD calculates the fan sound power level L_w (ref. 1 pW). The calculations are based on measurements carried out according to the following standards:

- EN ISO 5136:2009, Determination of sound power level in a duct.
- EN ISO 3741:2010, Determination of sound power level in reverberation rooms.

The SystemairCAD also calculates the sound power levels for all duct connections to the unit.

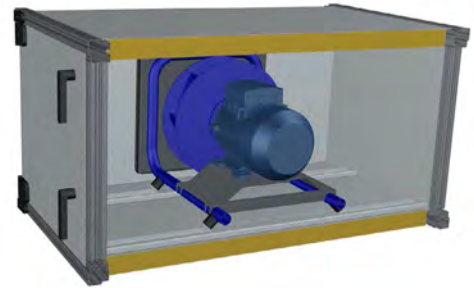

Balancing

The fan is balanced both statically and dynamically.

Operating temperatures

Temperature range: -10/+40 °C.

Airflow calculation

The inlet cone is equipped with a measuring nipple. This can be used to determine the current airflow using the k-factor and the formula:

$$V = \sqrt{\Delta P_m} \times k$$

V = Airflow in m³/h

ΔP_m = Measured pressure in Pa (according to sketch)

K = K-factor for the current fan (according to table).

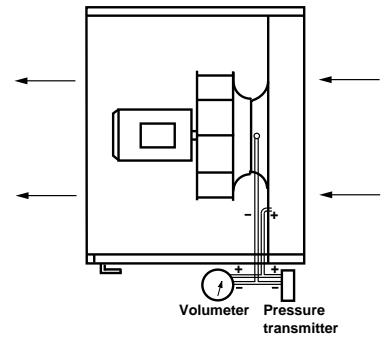

DVE-EC Blue			
Impeller ø mm	Material	K-factor	Fan type DVE-EC Blue
250	Composite	60	10-S
280	Composite	75	10-M
310	Composite	95	10-L, 15-M
350	Composite	121	15-L, 20-M
400	Composite	154	20-L, 25-M
450	Composite	197	25-L, 30-M
500	Composite	252	30-L, 40-M, 50-S
560	Composite	308	40-L, 50-M, 60-S
630	Composite	381	60-M, 80-S
2 x 450	Composite	394	50-L
2 x 500	Composite	504	60-L, 80-M, 100-S
2 x 560	Composite	616	80-L, 100-M, 120-S
2 x 630	Composite	762	100-L, 120-M, 150-S
3 x 560	Composite	924	120-L, 150-M, 190-S
4 x 560	Composite	1232	150-L, 190-M, 240-S
4 x 630	Composite	1524	190-L, 240-M
5 x 630	Composite	1905	240-L

DVE - PM/AC			
Impeller ø mm	Material	K-factor	Fan type DVE-PM/AC
220	Steel	47	10-S
250	Composite	60	10-M, 15-S
280	Composite	75	10-L, 15-M
310	Composite	95	15-L, 20-S
350	Composite	121	20-M, 25-S
400	Composite	154	20-L, 25-M, 30-S
450	Composite	197	25-L, 30-M, 40-S
500	Composite	252	30-L, 40-M, 50-S
560	Composite	308	40-L, 50-M, 60-S
2 x 450	Composite	394	50-L
630	Composite	381	60-M, 80-S
2 x 500	Composite	504	60-L
710	Steel	490	80-M, 100-S
2 x 560	Composite	616	80-L
800	Steel	620	100-M, 120-S
2 x 630	Composite	762	100-L
900	Steel	789	120-M, 150-S
2 x 710	Steel	980	120-L, 190-S
1000	Steel	999	150-M
2 x 800	Steel	1240	150-L, 190-M, 240-S
2 x 900	Steel	1578	190-L, 240-M
2 x 1000	Steel	1998	240-L

Plug Fan DVE

DVE 10-150

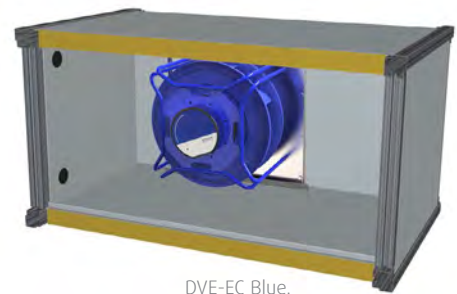
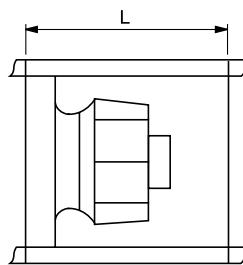
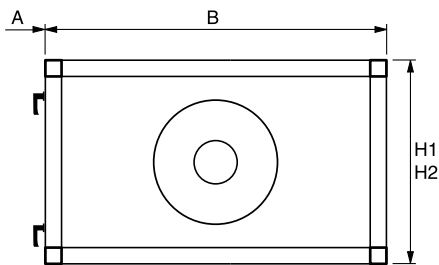

DVE-EC Blue.

H1: Single height unit.
H2: Double height unit.

DVE 190-240

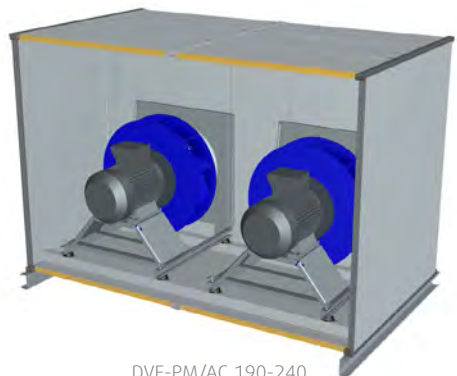
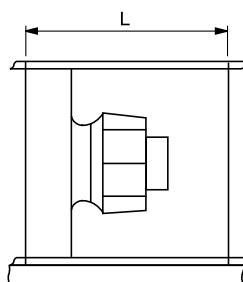
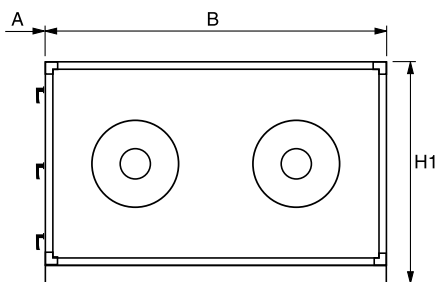

DVE-PM/AC 190-240

Dimensions

Size	10	15	20	25	30	40	50	60	80	100	120	150	190	240
B	970	1120	1270	1420	1570	1720	2020	2170	2170	2370	2590	2890	3190	3490
H1	520	595	670	745	820	895	1045	1120	1270	1420	1570	1720	2170	2470
H2	970	1120	1270	1420	1570	1720	2020	-	-	-	-	-	-	-
L, DVE-EC Blue-S	750	750	750	750	750	750	750	900	900	1050	1050	1200	1350	1350
L, DVE-EC Blue-M	750	750	750	750	750	750	900	900	1050	1050	1200	1350	1350	1350
L, DVE-EC Blue-L	750	750	750	750	750	750	900	1050	1050	1200	1350	1350	1350	1350
L, DVE-PM/AC-S	750	750	750	900	900	1050	1200	1200	1350	1650	1800	1950	1650	1800
L, DVE-PM/AC-M	750	750	750	900	900	1050	1200	1200	1350	1650	1800	1950	1650	2100
L, DVE-PM/AC-L	750	750	900	900	1050	1200	1050	1200	1200	1500	1650	1800	1950	2100
A* DVE-PM/AC	750	750	750	900	900	-	-	-	-	-	-	-	-	-
DVE-EC Blue duct connection on top														
L, DVE-EC Blue	750	750	750	750	750	750	1050	1050	1200	1350	1500	-	-	-

* Space needed for extracting the fan.

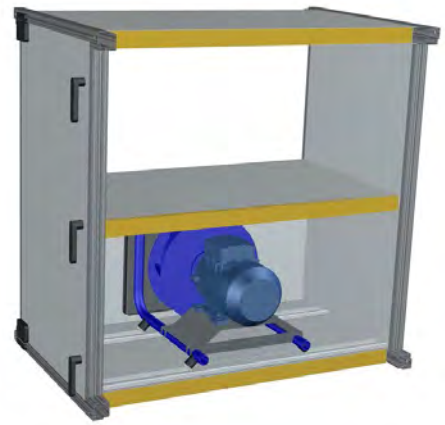

Fan fitted to the lower part of a double height unit.

DVE 10-150 duct connections

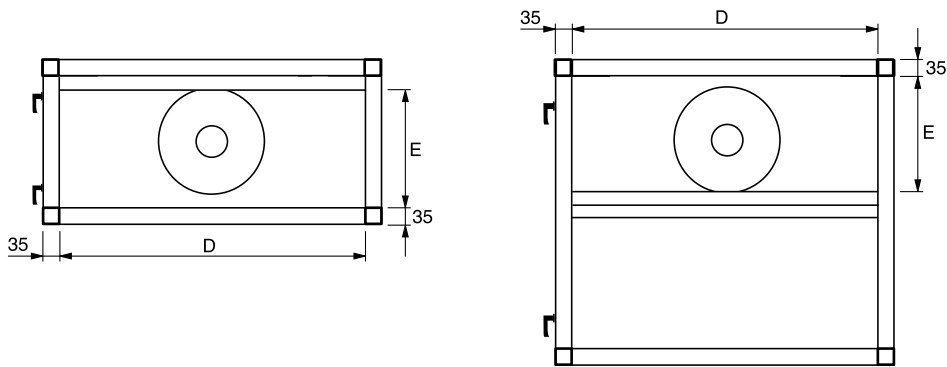

DVE 190-240 duct connections

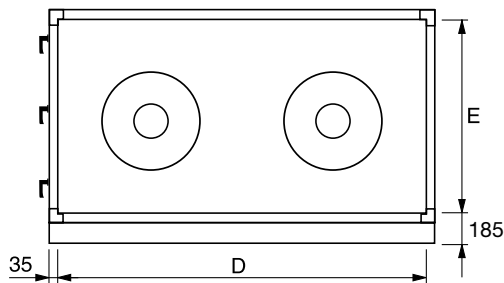

Connection variants

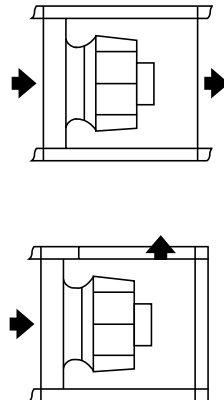

Duct connection on top

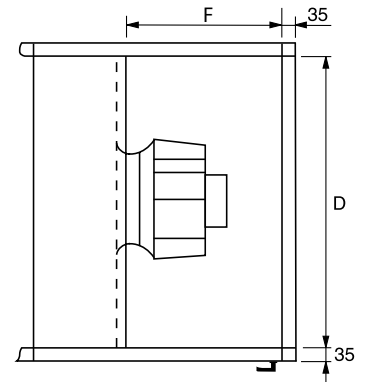

Dimensions

Size	10	15	20	25	30	40	50	60	80	100	120	150	190	240
D	900	1050	1200	1350	1500	1650	1950	2100	2100	2300	2520	2820	3120	3420
E	350	450	500	600	650	750	900	1000	1150	1300	1450	1600	1950	2250
F, DVE-EC Blue	350	450	500	600	600	600	900	1000	1150	1300	1450	-	-	-
F, DVE-PM/AC	350	450	500	600	650	750	900	1000	1150	1300	1450	1600	1500	1500

Sound Attenuator DVD



Function

Sound attenuator DVD is used to reduce the sound power level from the air handling unit to the duct system.

Construction

The sound attenuator is an absorption attenuator with baffles. The baffles are surface treated in order to prevent the absorption material fibres from being carried away.

Variants

- 1 – As an option, the air handling unit casing can be delivered with large inspection doors for easy cleaning.
- 2 – Baffles with a synthetic lining, ideal for wet cleaning. Each baffle is enclosed in a stainless steel frame. The air handling unit casing has large inspection doors, which makes it possible to pull out the baffles for cleaning.

Attenuation dB	Mid-frequency Hz							
	63	125	250	500	1000	2000	4000	8000
DVD-900	5	11	17	25	36	39	36	28
DVD-1200	7	15	23	32	43	46	43	36



Sound attenuator fitted to a single height unit.



Sound attenuator fitted to a double height unit.

DVD 10-150

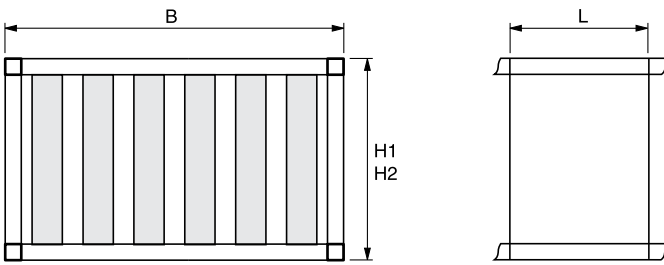

H1: Single height unit
H2: Double height unit

DVD 190-240

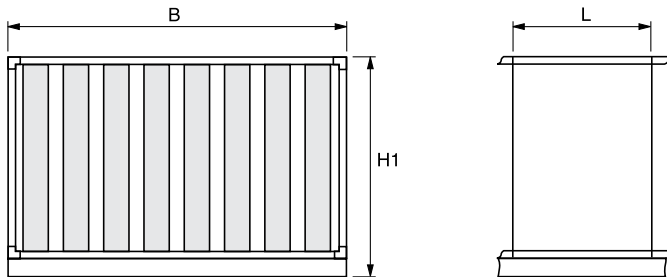

Dimensions

Size	10	15	20	25	30	40	50	60	80	100	120	150	190	240
B	970	1120	1270	1420	1570	1720	2020	2170	2170	2370	2590	2890	3190	3490
H1	520	595	670	745	820	895	1045	1120	1270	1420	1570	1720	2170	2470
H2	970	1120	1270	1420	1570	1720	2020	-	-	-	-	-	-	-
L	900	900	900	900	900	900	900	900	900	900	900	900	900	900
L	1200	1200	1200	1200	1200	1200	1200	1200	1200	1200	1200	1200	1200	1200

Inspection Section DVI



Function

DVI is used where the option of service, inspection or measuring is required, before or after an air handling function.

Construction

Inspection section DVI consists of an empty unit casing with an inspection door.

Accessories

Inspection window fitted into the access door. Bulkhead lamp with external switch.

DVI 10-150

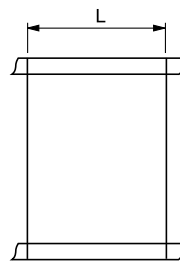
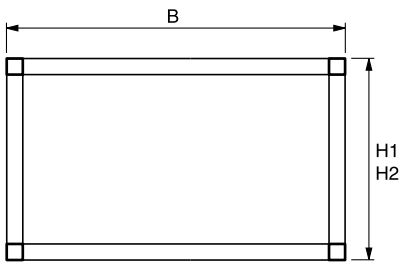

H1: Single height unit
H2: Double height unit

DVI 190-240

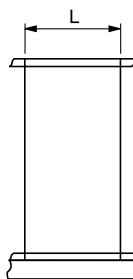
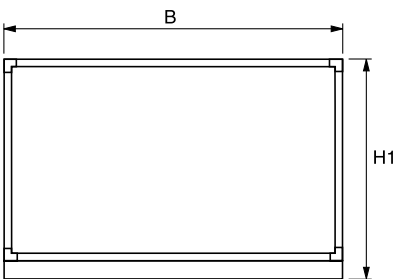

Dimensions

Size	10	15	20	25	30	40	50	60	80	100	120	150	190	240
B	970	1120	1270	1420	1570	1720	2020	2170	2170	2370	2590	2890	3190	3490
H1	520	595	670	745	820	895	1045	1120	1270	1420	1570	1720	2170	2470
H2	970	1120	1270	1420	1570	1720	2020	-	-	-	-	-	-	-
L	DVI 10-150: 300 - 450 - 600 - 750 - 900 - 1050 - 1200 - 1350 - 1500													
L	DVI 190-240: 300 - 450 - 600 - 750													

Empty Section DVO

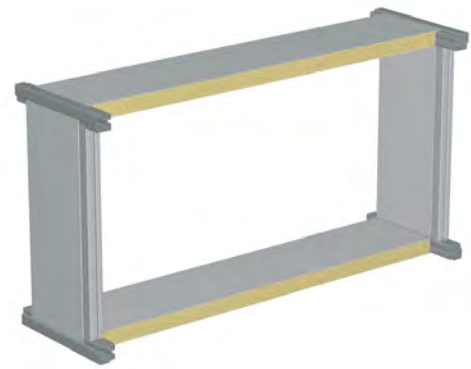

Function

Used in units where space is required to fit a component, e.g. a temperature sensor, or to have the option of applying an extra air handling function at a later date.

Construction

Empty section DVO consists of an empty unit casing, where the side panels are assembled with screws.

Accessories

Inspection window fitted into the access door. Bulkhead lamp with external switch.

DVO 10-150

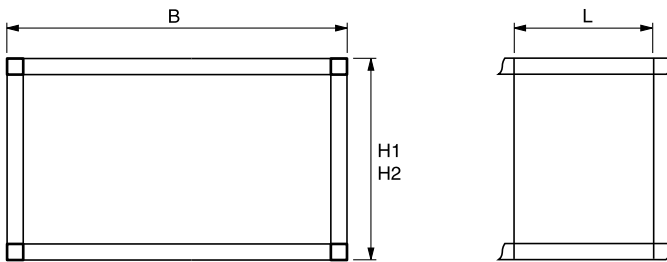

H1: Single height unit
H2: Double height unit

DVO 190-240

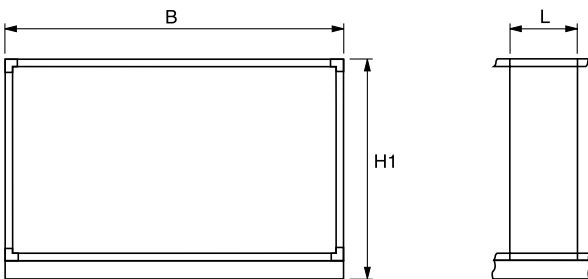

Dimensions

Size	10	15	20	25	30	40	50	60	80	100	120	150	190	240
B	970	1120	1270	1420	1570	1720	2020	2170	2170	2370	2590	2890	3190	3490
H1	520	595	670	745	820	895	1045	1120	1270	1420	1570	1720	2170	2470
H2	970	1120	1270	1420	1570	1720	2020	-	-	-	-	-	-	-
L	150 - 300 - 450 - 600 - 750 - 900 - 1050 - 1200 - 1350 - 1500													

Outdoor Air Section DVY



Function

Outdoor air section DVY is used for air intake and outlet in roof units for combinations of Danvent DV 10-150. DVY has air intake through the end of the unit, and outlet of exhaust air through the back wall of the unit, opposite the inspection side.

Construction

Outdoor air section DVY consists of an air handling unit casing with inspection door. The openings for air intake and outlet have louvers for effective protection against rain and snow.

Type 1

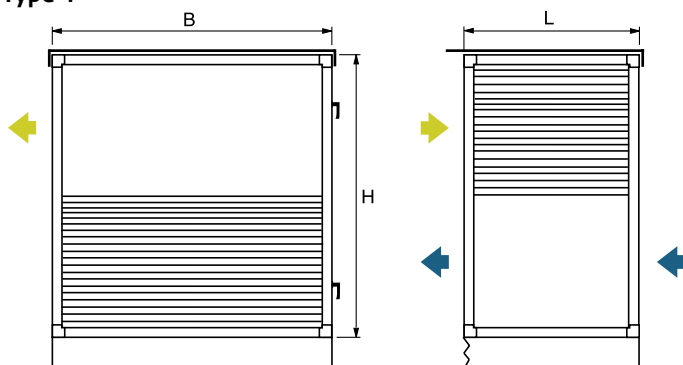

Type 2

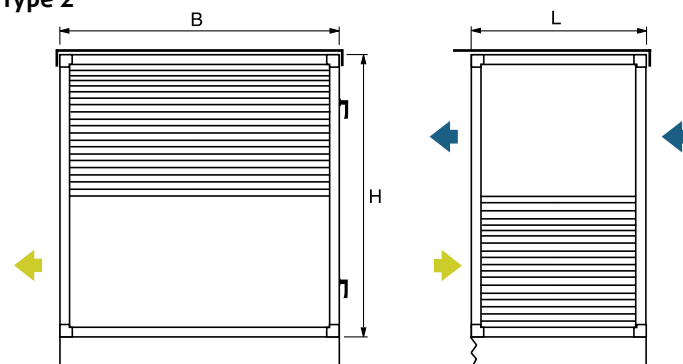

← Exhaust air Supply air →

Dimensions

Size	10	15	20	25	30	40	50	60	80	100	120	150
B	970	1120	1270	1420	1570	1720	2020	2170	2170	2370	2590	2890
H	970	1120	1270	1420	1570	1720	2020	2240	2540	2840	3140	3440
L	520	670	820	820	970	1120	1120	1420	1420	1570	1720	1720

Supporting Legs

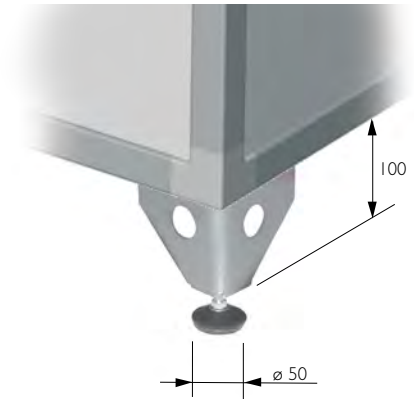

Function

Units in sizes DV 10-40 for indoor installation can be supplied with supporting legs.

Construction

Supporting legs are made of sturdy galvanized steel. They are 100 mm high, and have feet which are adjustable from 30-55 mm.

Base Frame DVZ

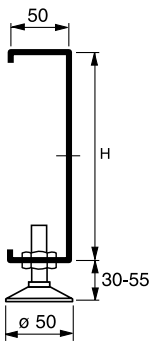

Function

Units in sizes DV 10-150 for indoor installation can be supplied with base frame in height 150 mm or 250 mm, and have feet which are adjustable from 30-55 mm. Units in sizes DV 190 and DV 240 are always supplied with 150 mm base frame. Units in sizes DV 10-150 for outdoor installation are always supplied with 250 mm base frame. Minimum length of base frame is 740 mm. Maximum length of base frame is 6200 mm. Units which are longer, are supplied divided on two or more base frames. Base frame DVZ is self-supporting,

but as a minimum it must be supported on the longitudinal profiles for each 1500 mm. Inserted, longitudinal profiles on units in sizes DV 50-240 do not require support.

Construction

The base frame consists of strong, galvanized steel profiles, in either 150 mm or 250 mm height assembled with bolts. For indoor installation feet are supplied, which are adjustable from 30-55 mm. As extra protection against corrosion 250 mm base frames for outdoor installation can be supplied hot dip galvanized.

Dimensions

B	L
Unit width	Unit length
	H
Indoor unit	150 og 250
Roof unit	250

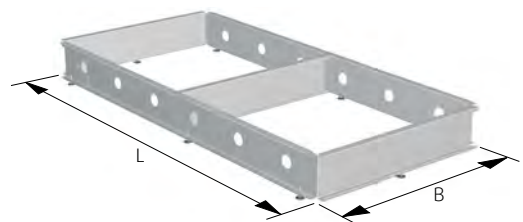

Dimensions for Ducts

Dimensions for ducts on the following unit functions:

Damper DVA 190-240	See page 20	Mixing damper DVP 190-240	See page 26
Damper DVB	See page 22	Fan DVE, outlet on top, 190-240	See page 52
Mixing damper DVM	See page 24		

Dimensions for ducts on all other unit functions:

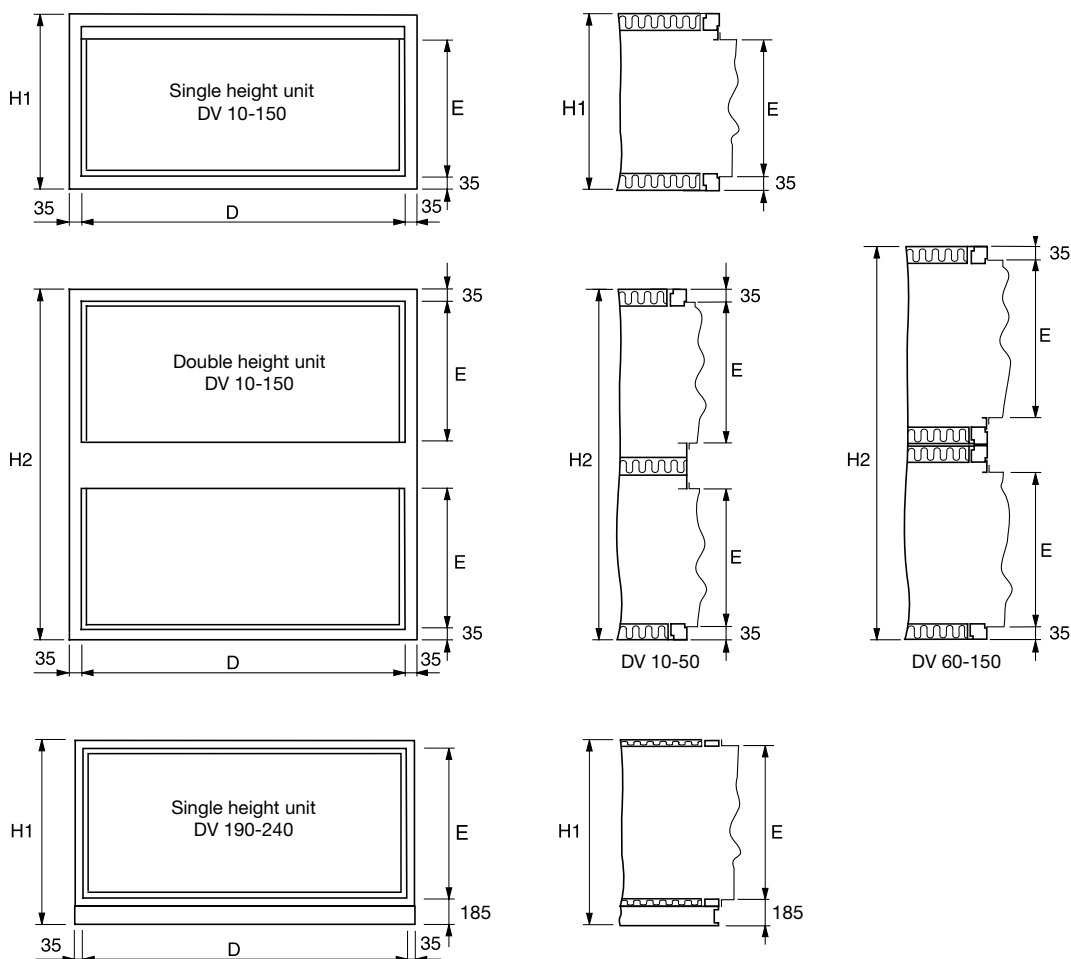

Dimensions for ducts on other unit functions

Size	10	15	20	25	30	40	50	60	80	100	120	150	190	240
D	900	1050	1200	1350	1500	1650	1950	2100	2100	2300	2520	2820	3120	3420
E	350	450	500	600	650	750	900	1000	1150	1300	1450	1600	1950	2250

The Danvent DV can be supplied with rigid or flexible duct connection part DVT. See page 63.

Duct Connection Part DVT

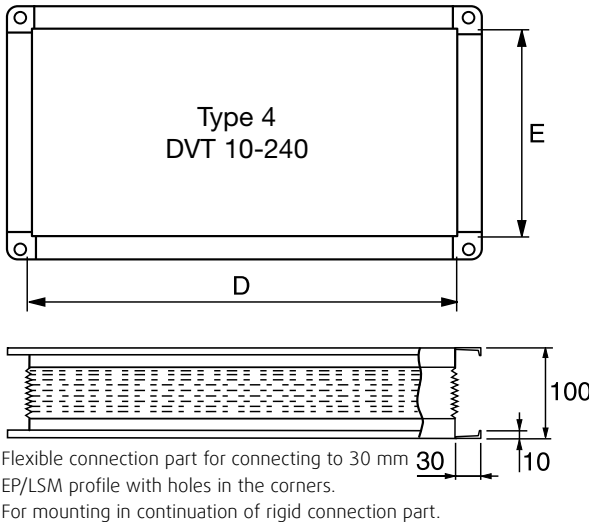
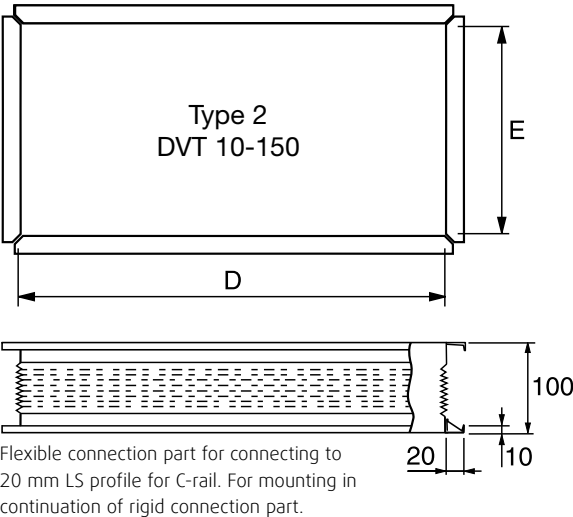
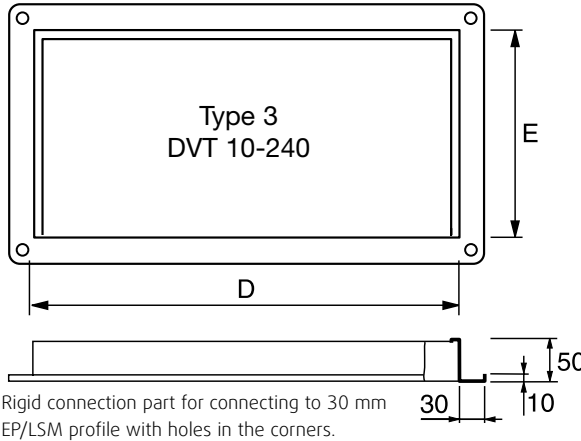
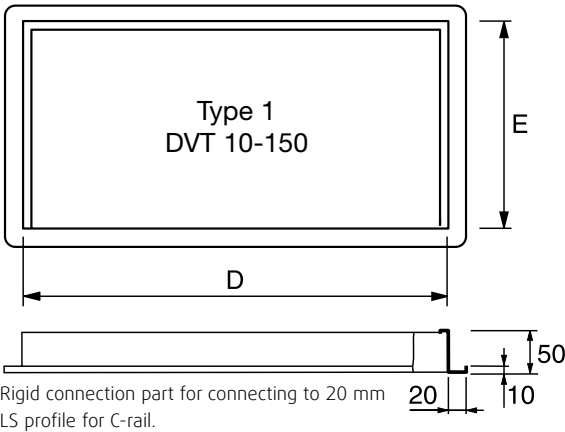

Function

Connection part DVT is used when connecting duct work to the Danvent DV air handling unit, either as rigid connection or as rigid and flexible connection.

Variant

- A - Damper DVA, mixing damper DVP
- B - Damper DVB, mixing damper DVM
- C - Others

Dimensions

Size	10	15	20	25	30	40	50	60	80	100	120	150	190	240
Variant A														
D	-	-	-	-	-	-	-	-	-	-	-	-	2600	2800
E	-	-	-	-	-	-	-	-	-	-	-	-	1500	1800
Variant B														
D	500	600	800	900	1100	1200	1500	1600	1700	1800	2000	2300	2600	2800
E	200	200	300	300	300	400	400	500	600	700	700	700	1000	1200
Variant C														
D	900	1050	1200	1350	1500	1650	1950	2100	2100	2300	2520	2820	3120	3420
E	350	450	500	600	650	750	900	1000	1150	1300	1450	1600	1950	2250



Systemair A/S
Ved Milepælen 7
DK-8361 Hasselager

Avedøreholmen 88
DK-2650 Hvidovre

Tel. +45 87 38 75 00

mail@systemair.dk
www.systemair.dk